

**BLAST CHILLER AND FREEZING
CELLULES DE REFRIFERATION RAPIDE ET CELLULES MIXTES
ABATEDORES DE TEMPERATURA**

**USE AND INSTALLATION MANUAL
MANUEL D'UTILISATION ET D'INSTALLATION
MANUAL DE US**



GB

Carefully read the instructions contained in the handbook. You may find important safety instructions and recommendations for use and maintenance.

Please retain the handbook for future reference.

The Manufacturer is not liable for any changes to this handbook, which may be altered without prior notice.

FR

Lire avec attention les instructions contenues dans ce livret car elles fournissent d'importants renseignements pour ce qui concerne la sécurité, l'emploi et l'entretien.

Garder avec soin ce livret pour des consultations ultérieures de différents opérateurs.



Le constructeur se réserve le droit d'apporter des modifications à ce manuel, sans préavis ni responsabilité d'aucune sorte.

P

Leia com atenção as advertências contidas neste manual pois fornecem importantes indicações para a segurança, a utilização e a manutenção do aparelho.

O construtor reserva-se o direito de modificar o manual sem dar aviso prévio e sem nenhuma responsabilidade.

- INDEX -

1 st PART		INSTRUCTION MANUAL	3
2 st PART		INSTALLATION MANUAL	31

0	INFORMATION FOR THE READER	3
1	GENERAL INSTRUCTIONS ON DELIVERY	3
	• GENERAL INSTRUCTIONS	3
	• TECHNICAL DATA	3
	• LIST OF REGULATION REFERENCES	3
	• GENERAL INSTRUCTIONS	3
	• SETTING UP	4
	• TESTING	4
	MACHINE LOADING	5
	POSITION OF TRAYS	5
	LENGTH	5
2	CONTROL PANEL	7
	• DESCRIPTION OF CONTROLS	7
	• CORE PROBE	8
	• GENERAL SETTING	8
	LANGUAGE	8
	CLOCK	9
	TEMPERATURE UNIT OF MEASUREMENT	9
3	WORKING	11
	PRE-COOLING CYCLE	11
	• QUICK COOLING CYCLE	11
	IFR POSITIVE QUICK COOLING CYCLE	13
	CORE PROBE POSITIVE QUICK COOLING CYCLE	14
	CORE PROBE NEGATIVE QUICK COOLING CYCLE	15
	TIME-CONTROLLED POSITIVE QUICK COOLING CYCLE	16
	TIME-CONTROLLED NEGATIVE QUICK COOLING CYCLE	17
	CORE PROBE HARD QUICK COOLING CYCLE	18
	TIME-CONTROLLED HARD QUICK COOLING CYCLE	19
	• STORING CYCLE	21
	POSITIVE STORING CYCLE	21
	NEGATIVE STORING CYCLE	22
	• MEMORIZING PROGRAMMES	23
	• USING MEMORIZED PROGRAMMES	23
	• USING RECOMMENDED PROGRAMMES	24
	• DEFROSTING	24
4	ACCESSORIES	26
	• PRINTING MEMORIZED CYCLES	26
5	MAINTENANCE	27
	• MAINTENANCE AND CLEANING	27
	CLEANING THE CABINET	27
	CLEANING THE AIR CONDENSER	28
	STAINLESS-STEEL MAINTENANCE	28
	DISCONTINUED USE	29



- INDEX -

• INSTALLATION	31
INTRODUCTION	31
MAX ROOM TEMPERATURE	31
POSITIONING	31
WIRING	33
PLEASE USE CERTIFIED APPROVED MATERIALS	33
REFRIGERATING CONNECTION	33
CONNECTION TO CONDENSATE DRAIN	33
• GENERAL SETTING	34
TESTING	34
LANGUAGE	34
CLOCK	35
TEMPERATURE UNIT OF MEASUREMENT	35
• PRINTER INSTALLATION	36
• SERVICE FUNCTIONS	36
CHANGING PARAMETERS	36
DESCRIPTION OF PARAMETERS	37
• ALARMS AND FAULT ANALYSIS	40
• DISPLAYING INPUTS/OUTPUTS STATE	41
• DISPLAYING THE LATEST DEFROST CYCLES	42
• DISPLAYING DOOR OPENINGS	42
• ALARMS AND USER PROGRAMMES CANCELLATION	43
• RESTORING PRE-SET PARAMETERS	44
• MAINTENANCE OF PANEL BOARD	45
• WIRING DIAGRAM PLATE	46
• CONTROL AND SAFETY SYSTEMS	46
• DISPOSAL	46
• REFRIGERANT MATERIAL SAFETY DATA SHEET	47
• DIMENSIONS	48
ANNEXES	49



- INSTRUCTION MANUAL -

INFORMATION FOR THE READER

CHAPTER 0

This manual is subdivided into two parts.



1st part: covers all the information necessary to the user.



2nd part: covers all the information necessary to the qualified operators authorized to move, transport, install, service, repair and demolish the appliance.

While users are instructed to refer to the 1st part only, the 2nd part is addressed to skilled operators. They may also read the 1st part for a more complete picture of the information provided if necessary.

GENERAL INSTRUCTIONS ON DELIVERY

CHAPTER 1

GENERAL INSTRUCTIONS

Make sure that the consignment has not been tampered with or damaged during transport.

After unpacking the cooling cabinet make sure all sections or components have been included and specifications and conditions are as to your order. If not, please inform the retailer immediately.

We assure you have made the best choice in purchasing our products and hope you will be fully satisfied with our their performance. To this purpose, we recommend you strictly comply with the instructions and regulations contained in this handbook.

Please remember that no reproductions of this handbook are allowed. Due to our constant technological updating and research, the features described in this handbook may be altered without prior notice.



TECHNICAL DATA

Please refer to the technical data of your own appliance. (tab.1a-1b)

LIST OF REGULATION REFERENCES

The cooling cabinet we manufacture fully complies with the following regulations:

UL Listed for electrical safety
NSF standard 7 for sanitation

GENERAL INSTRUCTIONS

The quick cooler is a refrigerating appliance which can cool cooked foodstuffs to a temperature of +38 [°F] (positive quick cooling) and to 0 [°F] (negative quick cooling).

Machine capacity as to the quantity to be cooled depend on the model purchased.

- INSTRUCTION MANUAL -

SETTING UP

Before setting to operation thoroughly clean the cooling cabinet with a suitable detergent or sodium bycarb dissolved in lukewarm water. Clean the appliance inside to remove any condensate caused by the Manufacturer's final testing.

Cooling and freezing speed depends on the following factors:

- a) container shape, type and material;
- b) whether container lids are used;
- c) foodstuff features (density, water contents, fat contents);
- d) starting temperature;
- e) thermal conduction inside the foodstuffs

Positive /Negative quick cooling time depends on type of foodstuffs to be processed.

Full-speed cycle is recommended for high-density or large-sized foodstuffs. However, the following limits should never be exceeded : a 7.1 pounds load for 12"x20"x2-1/2" or 14 pounds load for 18"x26", a 2" thickness or freezing and an 3" thickness for cooling (**tab.2**).

The low-speed cycle is suitable to process delicate foodstuffs, such as vegetables, creamy products, creamy desserts or low-thickness products.

We recommend making sure that any positive quick cooling cycles, up to +38 [°F] to the core of the product, do not last over 90 minutes, and that negative quick cooling cycles, up to 0 [°F] to the core of the product, do not last over 4 hours.

The processing room is to be pre-cooled before starting the positive and /or negative quick cooling cycle. Moreover, avoid covering the foodstuffs during the cycle, which would increase the cycle length.

We recommend using the core probe in order to have the exact core temperature reading. Do not stop the cycle before reaching a temperature of +38 [°F] during positive quick cooling and 0 [°F] during negative quick cooling.



Tab.2

Model	Max. output/cycle		Capacity	
	+160[°F]÷+38[°F]	+160[°F]÷+0[°F]	n° max	
IM51M-IM51C	44[lb]	24[lb]	5	12"x20"x1.5"
			4	12"x20"x2.5"
IR51M-IR51C	40[lb]	-	5	12"x20"x1.5"
			4	12"x20"x2.5"
IM101L-IM101S	93[lb]	55[lb]	14	12"x20"x1.5"
			8	12"x20"x2.5"
IR101L-IR101S	80[lb]	-	14	12"x20"x1.5"
			8	12"x20"x2.5"
IM72S	115[lb]	55[lb]	26	12"x20"x1.5"
			14	12"x20"x2.5"
			13	18"x26"x1.5"
			7	18"x26"x2.5"
IR72S	113[lb]	-	26	12"x20"x1.5"
			14	12"x20"x2.5"
			13	18"x26"x1.5"
			7	18"x26"x2.5"
IM102S	220[lb]	110[lb]	32	12"x20"x1.5"
			20	12"x20"x2.5"
			16	18"x26"x1.5"
			10	18"x26"x2.5"

TESTING

Name and Surname	Address	Tel./fax no.

- INSTRUCTION MANUAL -

MACHINE LOADING

Do not pile up foodstuffs to be cooled. Thickness should be lower than 2" in negative quick cooling and lower than 3" in positive quick cooling. **(pict.1)**

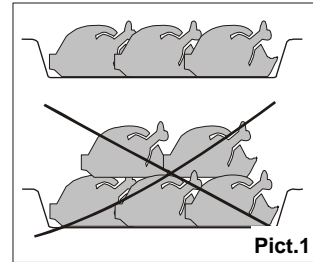

Make sure air circulation is not hampered between food trays. **(pict.2)**

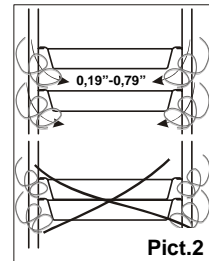

The grid-holding frame (included in those models which include trolleys) is to be located at the centre of the cabinet. **(pict.3)**

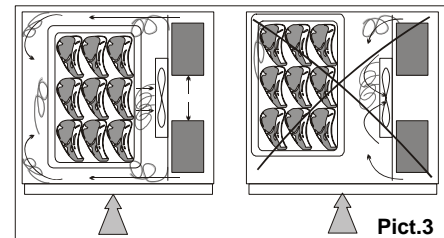

POSITION OF TRAYS

Place the trays as close to the evaporator as possible. **(pict.4)**

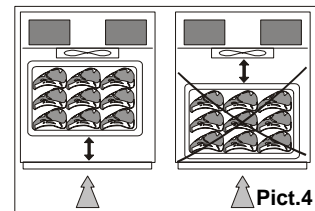

If the cabinet is not full place the trays at equal distance from one another. **(pict.5)**

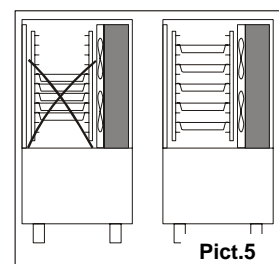

LENGTH

Cooled or frozen processed foodstuffs may be stored in a refrigerator for 5 days of processing with no quality alterations.

For best results we recommend keeping temperature constant throughout the storing (32[°F] to 38[°F]), according to the various commodities.

Storing time may be increased to approx. two weeks by using vacuum processing.

After a negative quick cooling cycle, foodstuffs may be stored safely for 3 to 18 months, according to the type of foodstuff processed.

We strongly recommend keeping storing temperature at 0[°F] or below.

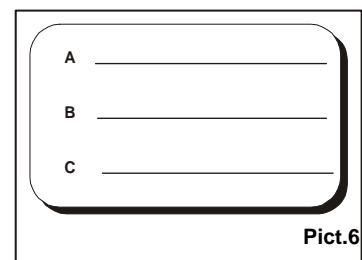

- INSTRUCTION MANUAL -

Table 3 shows the storing time rates for a few examples of frozen food.
Do not leave cooked products at room temperature before quick cooling.
Avoid any loss of moisture, which will affect food freshness.
The cooled product should be wrapped in a specific film for foodstuffs (better still, vacuum stored) and provided with a sticker reporting the content [A], date of processing [B] and expiry date [C] written in permanent type ink (**pict.6**).

Tab.3

Foodstuff	Storing temperature [°F]	Recommended storing time
Pork	0	6
Beef	0	9
Poultry	0	10
Fat fish	0	2
Lean fish	0	4
Peas	0	12
Strawberries	0	12
Spinach	0	6









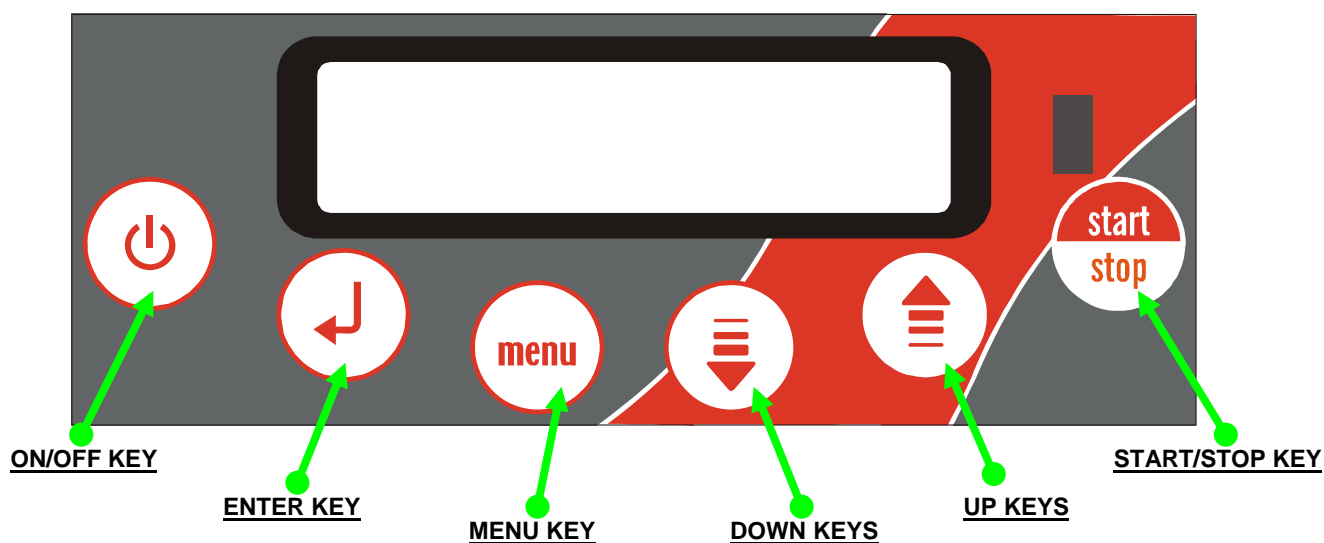

- INSTRUCTION MANUAL -

CONTROL PANEL

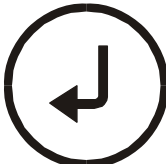
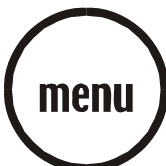
CHAPTER 2

DESCRIPTION OF CONTROLS



	<p>ON/OFF key Pressing the key for 5 sec the controller turns off and the sign blinks on the display OFF Pressing the key again the controller restarts in the Stand-By mode.</p>
	<p>Enter key Allows access to a menu or parameter selection.</p> <p>Manual defrost: press the key fro 5 s</p>
	<p>Menu key Allows access to the main menu or return to the previous menu.</p> <p>IFR Quick cooling: press the key for 5 s</p>
	<p>Up e Down keys Allow to scroll the different menus or change parameter values.</p> <p>Quick cooling pos.: press the key  for 5 s</p> <p>Quick cooling neg.: press the key  for 5 s</p> <p>Keyboard lock: press the keys   for 5s</p>
	<p>Start/Stop key Allow to start/stop a quick cooling cycle.</p>



- INSTRUCTION MANUAL -

CORE PROBE

For proper position of the probe, refer to the following pictures.

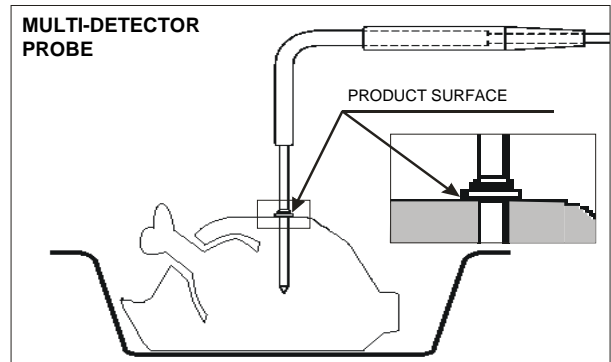
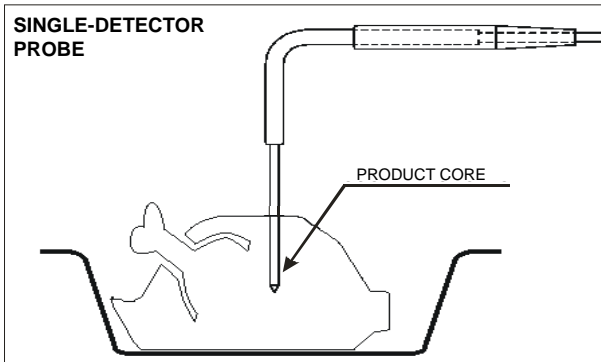

GENERAL SETTING







LANGUAGE











	Press the menu key to select the desired menu
	Use the keys up and down to display
	Press the enter key to gain access to the setting submenus The display shows
	Use the keys up and down to select the password "-19"
	Press enter to confirm your choice
	Use the keys up and down to display
	Press enter to display the first language available
	Use the keys up and down to select the desired language
	Press enter to confirm your choice
	Press menu several times to exit

- INSTRUCTION MANUAL -

CLOCK



	Press the menu key to select the desired menu
	Use the keys up and down to display Menu 06 Clock Setting
	Press enter to gain access to the clock setting mode The display shows Date: 06/11/05 Hour: 14:22:46
	Use the keys up and down to change the flashing digit
	Press enter to confirm and pass to the next value
	Press menu several times to exit

TEMPERATURE UNIT OF MEASUREMENT

	Press the menu key to select the desired menu
	Use the keys up and down to display Menu 05 Set Up
	Press the enter key to gain access to the setting submenus The display shows Set Up Password 0
	Use the keys up and down to select the password “-19”
	Press enter to confirm your choice
	Use the keys up and down to display Set Up 03 Parameters
	Press enter to gain access to the parameter programming mode The first parameter is displayed A01 = 23°F Low Alarm
	Use the keys up and down to display parameter D01 D01 = 0
	Press enter to confirm your choice



- INSTRUCTION MANUAL -

	Use the keys up and down to select the new value (0 Celsius, 1 Fahrenheit)
	Press enter to confirm your choice
	Press menu several times to exit











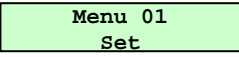

- INSTRUCTION MANUAL -

OPERATION

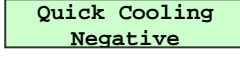
CHAPTER 3

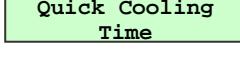
PRE-COOLING CYCLE

We recommend starting a pre-cooling cycle before selecting quick cooling cycles.

	Press the menu key to select the desired menu
	Use the keys up and down to display 
	Press enter to gain access to the mode for setting quick cooling cycles Set 
	Use the keys up and down to pass to the next values Set 
	Press enter to change the flashing values
	Press the key start/stop to start the pre-cooling cycle immediately
	Once the temperature of -4[°F] has been reached, press the key start/stop to interrupt the pre-cooling cycle



QUICK COOLING CYCLE

- **IFR POSITIVE QUICK COOLING CYCLE:** automatic cycle preventing the product surface (any thickness and material) from freezing, while respecting the multi-detector core probe insertion.
- **CORE PROBE POSITIVE QUICK COOLING CYCLE :** cycle suitable for cooling foodstuffs with thickness lower than 1,5" using a room temperature of about +32[°F]. The cycle is controlled by the core probe.
- **CORE PROBE NEGATIVE QUICK COOLING CYCLE:** cycle suitable for freezing foodstuffs using a room temperature of about -22[°F]. The cycle is controlled by the core probe.
- **TIME-CONTROLLED POSITIVE QUICK COOLING CYCLE:** cycle suitable for cooling foodstuffs with thickness lower than 1,5" using a room temperature of about +32[°F]. The cycle is time-controlled.
- **TIME-CONTROLLED NEGATIVE QUICK COOLING CYCLE :** cycle suitable for freezing foodstuffs using a room temperature of about -22[°F]. The cycle is time-controlled.
- **CORE PROBE HARD QUICK COOLING CYCLE :** cycle suitable for cooling foodstuffs with thickness exceeding 1,5" using a room temperature ranging from -22[°F] to +23[°F]. The cycle is controlled by the core probe.

- INSTRUCTION MANUAL -

- **TIME-CONTROLLED HARD QUICK COOLING CYCLE** : cycle suitable for cooling foodstuffs with thickness exceeding 1,5" using a room temperature ranging from -22[°F] to +23[°F]. The cycle is time-controlled.

NOTE: At the end of the quick cooling phase, the device starts the storing phase (+28[°F] at the end of the positive quick cooling; -7[°F] at the end of the negative quick cooling).

Cooling time

FOODSTUFF	SHEET	MAX. LOAD	PRODUCT THICKNESS	QUICK COOLING TIME	CYCLE
FIRST COURSES					
Bechamel	GN1/1 h60	0,21 cuft	1,5"	70 minutes	HARD
Meat broth	GN1/1 h110	0,28 cuft	2,7"	110 minutes	HARD
Cannelloni	GN1/1 h40	9 lbs	1,5"	40 minutes	HARD
Vegetable soup	GN1/1 h100	0,17 cuft	2"	100 minutes	HARD
Fresh pasta	GN1/1 h40	0,5 lbs	2"	20 minutes	NEGATIVE
Meat and tomato sauce	GN1/1 h60	11 lbs	2"	90 minutes	HARD
Bean soup	GN1/1 h60	11 lbs	2"	100 minutes	HARD
Fish soup	GN1/1 h60	9 lbs	2"	110 minutes	HARD
MEAT AND POULTRY					
Roast pork	GN1/1 h60	17,7 lbs	4"	110 minutes	HARD
Braised beef	GN1/1 h60	17,7 lbs	6"	110 minutes	HARD
Boiler beef	GN1/1 h60	13,24 lbs	6"	110 minutes	HARD
Chicken breast	GN1/1 h40	11 lbs	2"	30 minutes	SOFT
Roast-beef	GN1/1 h40	9 lbs	4"	80 minutes	HARD
FISH					
Baked grouper	GN1/1 h40	6,5 lbs	2"	110 minutes	HARD
Squill	GN1/1 h40	4,4 lbs	1,2"	25 minutes	HARD
Vacuum-stored mussel	grid GN1/1	4,4 lbs	max 2,5"	20 minutes	HARD
Fish salad	GN1/1 h40	8,8 lbs	1,5"	30 minutes	POSITIVE
Boiled polyp	GN1/1 h60	11 lbs	-	60 minutes	HARD
Stewed cuttlefish	GN1/1 h60	8,8 lbs	2"	60 minutes	HARD
VEGETABLES					
Carrots trifolate	GN1/1 h60	8,8 lbs	2"	60 minutes	HARD
Mushrooms trifolati	GN1/1 h60	8,8 lbs	2"	60 minutes	HARD
Zucchini trifolate	GN1/1 h60	6,6 lbs	2"	90 minutes	HARD
PASTRY/DESSERT					
Vanilla / chocolate pudding	GN1/1 h60	0,21 cuft	2"	90 minutes	POSITIVE
Creme anglaise	GN1/1 h60	0,1 cuft	2"	100 minutes	POSITIVE
Custard a	GN1/1 h60	0,1 cuft	2"	100 minutes	POSITIVE
Panna cotta (single portion)	grid	0,1 cuft	2,3"	60 minutes	POSITIVE
Ice-cream cake	grid	6,6 lbs	2,3"	50 minutes	POSITIVE
Tiramisù	GN1/1 h60	11 lbs	2"	45 minutes	POSITIVE



- INSTRUCTION MANUAL -

IFR POSITIVE QUICK COOLING CYCLE





I.F.R.

(Intelligent Food Recognition)

The IFR is an innovative patented system of positive quick cooling which allows the cycle optimisation for each type of foodstuffs **by preventing superficial freezing.**

Temperatures are detected by a three-sensor multipoint needle probe. The position inside the foodstuff is determined univocally by a reference disk located along the needle. (ref. pag 8, par. "core probe").





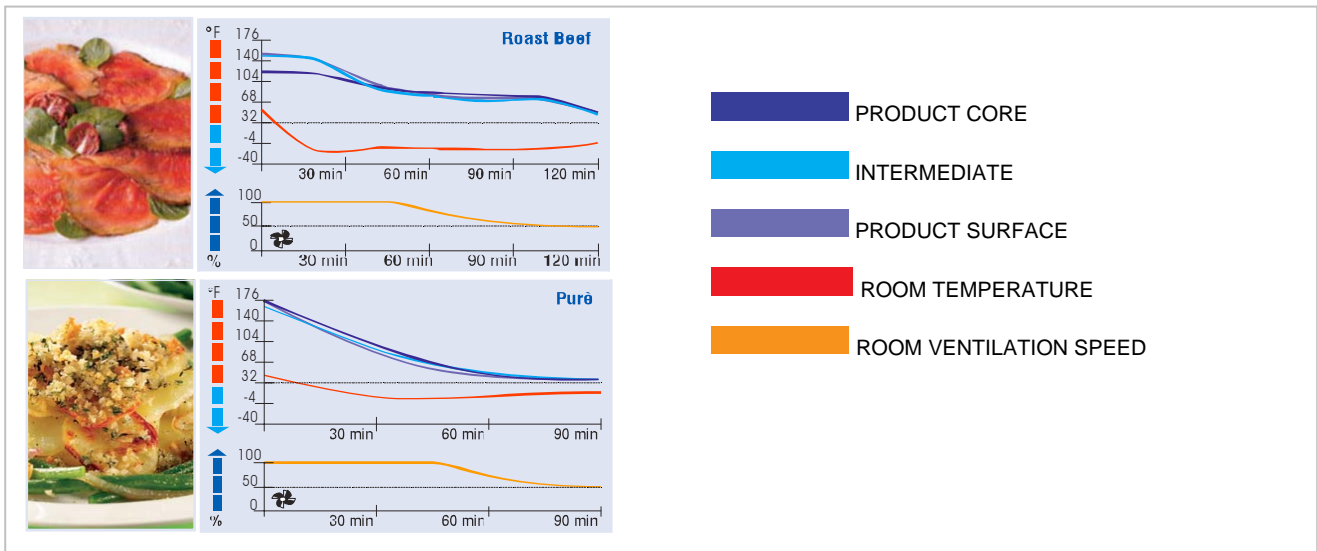











	Press the menu key to select the desired menu
	Use the keys up and down to display Menu 03 Programmes
	Press enter to gain access to the programme selecting mode The display shows Program IFR
	Press enter to confirm your choice
	Press the key start/stop to start the selected quick cooling cycle immediately







- INSTRUCTION MANUAL -

CORE PROBE POSITIVE QUICK COOLING CYCLE











	Press the menu key to select the desired menu
	Use the keys up and down to display Menu 01 Set
	Press enter to gain access to the mode for setting quick cooling cycles The display shows Quick Cooling Negative
	Press enter to change the flashing values
	Use the keys up and down to display Quick Cooling Positive
	Press enter to confirm your choice, the value stops flashing
	Use the keys up and down to pass to the next values The display shows Quick Cooling Time
	Press enter to change the flashing values
	Use the keys up and down to display Quick Cooling Core
	Press enter to confirm your choice, the value stops flashing
	Use the keys up and down to pass to the next values The display shows Set Point -25
	Press enter to change the flashing values
	Use the keys up and down to display the room temperature desired value
	Press enter to confirm your choice, the value stops flashing
	Use the keys up and down to pass to the next values The display shows Speed 50%



- INSTRUCTION MANUAL -







	Press enter to change the flashing values
	Use the keys up and down to display the desired value
	Press enter to confirm your choice, the value stops flashing
	Press the key start/stop to start the selected quick cooling cycle immediately

CORE PROBE NEGATIVE QUICK COOLING CYCLE

	Press the menu key to select the desired menu
	Use the keys up and down to display Menu 01 Set
	Press enter to gain access to the mode for setting quick cooling cycles The display shows Quick Cooling Negative
	Use the keys up and down to pass to the next values The display shows Quick Cooling Time
	Press enter to change the flashing values
	Use the keys up and down to display Quick Cooling Core
	Press enter to confirm your choice, the value stops flashing
	Use the keys up and down to pass to the next values The display shows Set Point -25
	Press enter to change the flashing values
	Use the keys up and down to display the desired value
	Press enter to confirm your choice, the value stops flashing















- INSTRUCTION MANUAL -









	Use the keys up and down to pass to the next values The display shows Speed 50%
	Press enter to change the flashing values
 	Use the keys up and down to display the desired value
	Press enter to confirm your choice, the value stops flashing
	Press the key start/stop to start the selected quick cooling cycle immediately

TIME-CONTROLLED POSITIVE QUICK COOLING CYCLE









	Press the menu key to select the desired menu
 	Use the keys up and down to display Menu 01 Set
	Press enter to gain access to the mode for setting quick cooling cycles The display shows Quick Cooling Negative
	Press enter to change the flashing values
 	Use the keys up and down to display Quick Cooling Positive
	Press enter to confirm your choice, the value stops flashing
	Use the keys up and down to pass to the next values The display shows Quick Cooling Time
	Press enter to change the flashing values
	Press enter to confirm your choice, the value stops flashing
	Use the keys up and down to pass to the next values The display shows Length 90 min

- INSTRUCTION MANUAL -









	Press enter to change the flashing values
	Use the keys up and down to display the desired value
	Press enter to confirm your choice, the value stops flashing
	Use the keys up and down to pass to the next values The display shows Speed 50%
	Press enter to change the flashing values
	Use the keys up and down to display the desired value
	Press enter to confirm your choice, the value stops flashing
	Press the key start/stop to start the selected quick cooling cycle immediately

TIME-CONTROLLED NEGATIVE QUICK COOLING CYCLE

	Press the menu key to select the desired menu
	Use the keys up and down to display Menu 01 Set
	Press enter to gain access to the mode for setting quick cooling cycles The display shows Quick Cooling Negative
	Use the keys up and down to pass to the next values The display shows Quick Cooling Time
	Press enter to change the flashing values
	Press enter to confirm your choice, the value stops flashing
	Use the keys up and down to pass to the next values The display shows Length 240 min









- INSTRUCTION MANUAL -













	Press enter to change the flashing values
	Use the keys up and down to display the desired value
	Press enter to confirm your choice, the value stops flashing
	Use the keys up and down to pass to the next values The display shows Speed 50%
	Press enter to change the flashing values
	Use the keys up and down to display the desired value
	Press enter to confirm your choice, the value stops flashing
	Press the key start/stop to start the selected quick cooling cycle immediately



CORE PROBE HARD QUICK COOLING CYCLE



	Press the menu key to select the desired menu
	Use the keys up and down to display Menu 01 Set
	Press enter to gain access to the mode for setting quick cooling cycles The display shows Quick Cooling Negative
	Press enter to change the flashing values
	Use the keys up and down to display Quick Cooling Hard
	Press enter to confirm your choice, the value stops flashing
	Use the keys up and down to pass to the next values The display shows Quick Cooling Time

- INSTRUCTION MANUAL -















	Press enter to change the flashing values
	Use the keys up and down to display Quick Cooling Core
	Press enter to confirm your choice, the value stops flashing
	Use the keys up and down to pass to the next values The display shows Set Point -25
	Press enter to change the flashing values
	Use the keys up and down to display the desired value
	Press enter to confirm your choice, the value stops flashing
	Use the keys up and down to pass to the next values The display shows Speed 50%
	Press enter to change the flashing values
	Use the keys up and down to display the desired value
	Press enter to confirm your choice, the value stops flashing
	Press the key start/stop to start the selected quick cooling cycle immediately



TIME-CONTROLLED HARD QUICK COOLING CYCLE

	Press the menu key to select the desired menu
	Use the keys up and down to display Menu 01 Set
	Press enter to gain access to the mode for setting quick cooling cycles The display shows Quick Cooling Negative

- INSTRUCTION MANUAL -

	Press enter to change the flashing values
	Use the keys up and down to display Quick Cooling Hard
	Press enter to confirm your choice, the value stops flashing
	Use the keys up and down to pass to the next values The display shows Quick Cooling Time
	Press enter to change the flashing values
	Press enter to confirm your choice, the value stops flashing
	Use the keys up and down to pass to the next values The display shows Length 90 min
	Press enter to change the flashing values
	Use the keys up and down to display the desired value
	Press enter to confirm your choice, the value stops flashing
	Use the keys up and down to pass to the next values The display shows Speed 50%
	Press enter to change the flashing values
	Use the keys up and down to display the desired value
	Press enter to confirm your choice, the value stops flashing
	Press the key start/stop to start the selected quick cooling cycle immediately













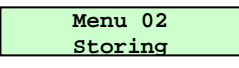

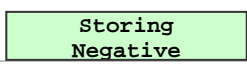

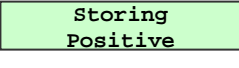

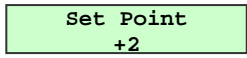
- INSTRUCTION MANUAL -

STORING CYCLE

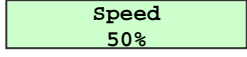
Storing cycles and quick cooling cycles can be started separately

POSITIVE STORING CYCLE

	Press the menu key to select the desired menu
	Use the keys up and down to display 
	Press enter to gain access to the mode for starting a storing cycle The display shows 
	Press enter to change the flashing values
	Use the keys up and down to display 
	Press enter to confirm your choice, the value stops flashing
	Use the keys up and down to pass to the next values The display shows 
	Press enter to change the flashing values
	Use the keys up and down to display the desired value
	Press enter to confirm your choice, the value stops flashing
	Use the keys up and down to pass to the next values The display shows 
	Press enter to change the flashing values
	Use the keys up and down to display the desired value
	Press enter to confirm your choice, the value stops flashing



- INSTRUCTION MANUAL -



Press the key start/stop to start the storing cycle immediately

NEGATIVE STORING CYCLE







	Press the menu key to select the desired menu
	Use the keys up and down to display Menu 02 Storing
	Press enter to gain access to the mode for starting a storing cycle The display shows Storing Negative
	Press enter to change the flashing values
	Press enter to confirm your choice, the value stops flashing
	Use the keys up and down to pass to the next values The display shows Set Point -22
	Press enter to change the flashing values
	Use the keys up and down to display the desired value
	Press enter to confirm your choice, the value stops flashing
	Use the keys up and down to pass to the next values The display shows Speed 50%
	Press enter to change the flashing values
	Use the keys up and down to display the desired value
	Press enter to confirm your choice, the value stops flashing
	Press the key start/stop to start the storing cycle immediately



- INSTRUCTION MANUAL -

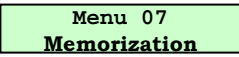

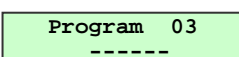





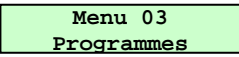

MEMORIZING PROGRAMMES

It is possible to memorize up to 20 USER programmes.
The last set programme can be memorized as follows:

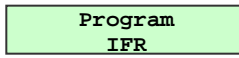
	Press the menu key to select the desired menu
	Use the keys up and down to display 
	Press enter to gain access to the mode for memorizing a quick cooling cycle previously set The display shows the programme number and indicates whether it is already memorized or not 
	Use the keys up and down to scroll all programmes from 01 to 20, and select the desired number to save the programme
	Press enter to confirm your choice

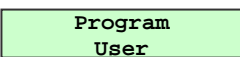
USING MEMORIZED PROGRAMMES

The memorized USER programmes can be activated as follows:







	Press the menu key to select the desired menu
	Use the keys up and down to display 
	Press enter to gain access to the programme selecting mode The display shows 
	Use the keys up and down to display 
	Press enter to gain access to the User programmes selection (1-20) The display shows the programme number as well as the type of cycle memorized
	Use the keys up and down to scroll all the memorized programmes
	Press the key start/stop to start the selected quick cooling cycle immediately



- INSTRUCTION MANUAL -

USING RECOMMENDED PROGRAMMES

PRESET programmes are working cycles recommended by the manufacturer. Parameters cannot be changed.



	Press the menu key to select the desired menu
	Use the keys up and down to display Menu 03 Programmes
	Press enter to gain access to the programme selecting mode The display shows Program IFR
	Use the keys up and down to display Program Preset
	Press enter to gain acces to the memorized programmes selection (21-29) The display shows the programme number and name Program 21 MEATS
	Use the keys up and down to scroll all the memorized programmes
	Press the key start/stop to start the selected quick cooling cycle immediately





The recommend programmes are listed below:

Prog	Name of the programme	Positive negative	Time/Core	hard	Room set storing	time	Ventilat.
21	QC meats	positive	core	yes	+35°F	120 min	100%
22	QC creams	positive	time	no	+35°F	90 min	100%
23	QC pies	positive	time	no	+35°F	90 min	100%
24	QC compounds	positive	time	no	+35°F	90 min	100%
25	QC ichthyc products	positive	time	yes	+35°F	90 min	100%
26	QC avicultural products	positive	time	yes	+35°F	90 min	100%
27	vegetables	positive	time	no	+35°F	90 min	100%
28	Temper. freezing	negative	core	yes	-8°F	240 min	100%
29	Time freezing	negative	time	yes	-8°F	240 min	100%

DEFROSTING

	Press the menu key to select the desired menu
	Use the keys up and down to display Menu 04 Defrost

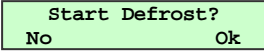
- INSTRUCTION MANUAL -

	Press enter to gain access to the defrost activation The display shows 
	Press Up to start defrost
	Press the key start/stop to stop defrost.

Note: immediate defrost can be started from the main menu by pressing the key  for at least 5 seconds



- INSTRUCTION MANUAL -

ACCESSORIES

CHAPTER 4





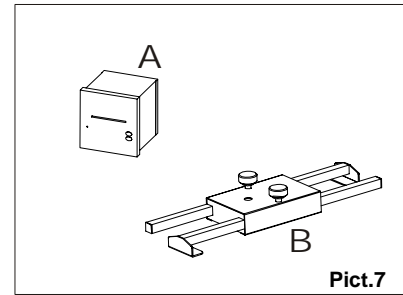

The following accessories are available upon request. (pict.7)

- A) THERMAL PRINTER
- B) PROBE SUPPORT (useful in quick cooling cycles for liquid foodstuffs)

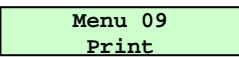

PRINTING MEMORIZED CYCLES

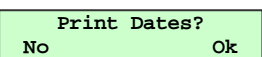
NOTE: the printer is not supplied as standard equipment. It is an optional item.

	Press the menu key to select the desired menu
	Use the keys up and down to display 
	Press enter to gain access to the mode for printing the quick cooling cycles memorized The display shows 
	Press Up to start printing the memorized cycles



- INSTRUCTION MANUAL -

MAINTENANCE

CHAPTER 5

MAINTENANCE AND CLEANING

CLEANING THE CABINET

Clean inside the cooling cabinet daily.

Both the cabinet and all the internal components have been designed and shaped to allow washing and cleaning all parts easily.

Before cleaning, defrost the appliance and remove the internal drain.

Disconnect the master switch.

Clean all components (stainless-steel, plastic or painted parts) with lukewarm water and detergent.

Then rinse and dry without using abrasives or chemical solvents. **(pict.8)**

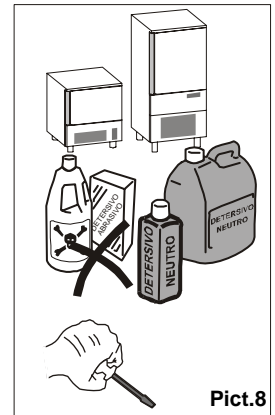

Do not wash the appliance by spraying high-pressure water on the machine. **(pict.9)**

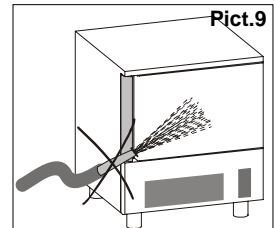

Do not rinse with sharp or abrasive tools, especially the evaporator. **(pict.10)**

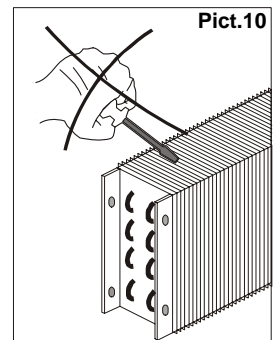

You may clean inside the evaporator after loosening the knobs and rotating the protection component. **(pict.11)**

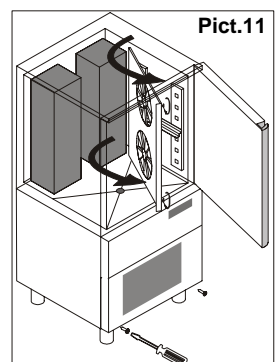

Remove the front control board with a tool and clean the raceway to remove all dirt. **(pict.12)**

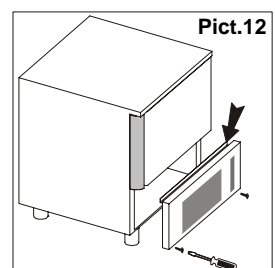

- INSTRUCTION MANUAL -

Wash the door gasket with water. Accurately dry with a dry cloth. We recommend wearing protecting gloves throughout the operations. (pict.13)

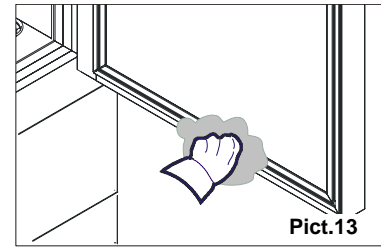

Pict.13

Hand-wash the probe using lukewarm water and a mild detergent or products with biodegradability higher than 90%. Rinse with water and sanitary solution. Do not use detergents containing solvents (such as trichloroethylene, etc) or abrasive powders

ATTENTION: do not use hot water to wash the probe (pict.14)

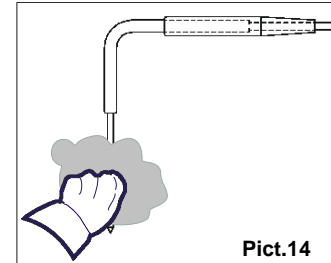

Pict.14

CLEANING THE AIR CONDENSER

The air condenser should be kept clean to ensure the appliance's performance and efficiency, as air should freely circulate inside the appliance. (pict.15)

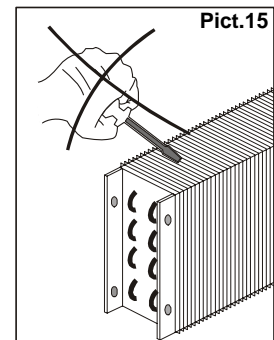

Pict.15

The condenser should therefore be cleaned every 30 days, using non-metal brushes to remove all dust and dirt from condenser blades.



Access to the condenser is obtained by removing the front panel. (pict.16)

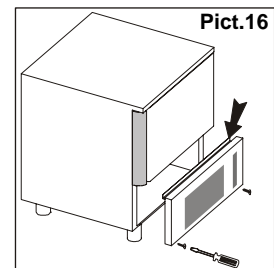

Pict.16

STAINLESS-STEEL MAINTENANCE

By stainless steel we mean INOX AISI 304 steel. We recommend following the instructions below for the maintenance and cleaning of stainless-steel parts. This is of the utmost importance to ensure the non-toxicity and complete hygiene of the processed foodstuffs. Stainless-steel is provided with a thin oxide layer which prevents it from rusting. However, some detergents may destroy or affect this layer, therefore causing corrosion. Before using any cleansing product, ask your dealer about a neutral chloriness cleansing product, as to avoid steel corrosions. If the surface has been scratched polish it with fine STAINLESS-STEEL wool or a synthetic-fibre abrasive sponge. Always rub in the direction of the silking. (pict.17)

WARNING: Never use iron wool for cleaning STAINLESS STEEL. Furthermore, avoid leaving iron wool on the appliance surface as tiny iron deposits may cause the surface to rust by contamination and affect the hygiene of the appliance.

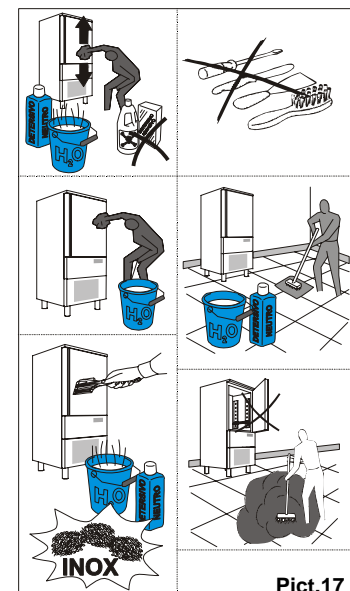

Pict.17

- INSTRUCTION MANUAL -

DISCONTINUED USE

Should the machine be disconnected over long periods, follow the instructions below to maintain the appliance in good condition:

Turn the mains switch OFF. (**pict.18**)

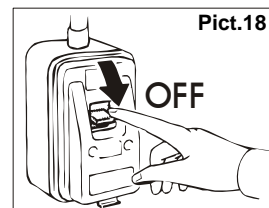

Disconnect the plug. (**pict.19**)

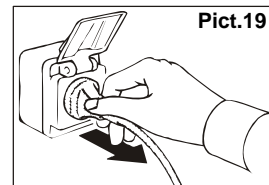

Empty the appliance and clean it in accordance with the instructions given in the chapter "CLEANING". Leave the door ajar to prevent a bad smell.

Cover the compressor unit with a nylon cloth to protect it from dust. (**pict.20**)

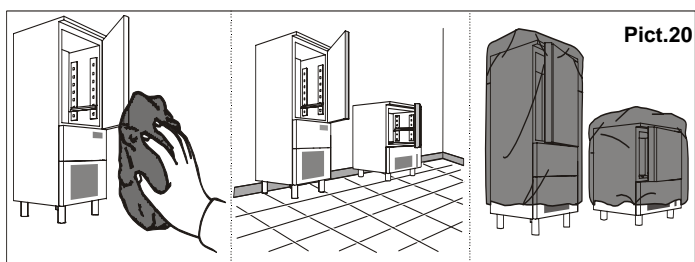

In case of appliances with remote control, if you decide to turn it off, remember to put the switch off also in the remote control.



- INSTALLATION MANUAL -

INSTALLATION

INTRODUCTION

After unpacking the appliance make sure it has not been damaged. **(pict.21)**
 Make sure the technical wiring specifications comply with the ratings (i.e., V, kW, Hz, no. phases and mains power). Check the power supply type, adjustments, performance and calibration of the device located before the appliance. Check and record the coolant type inside the system and refer to the recorded data in any refill.

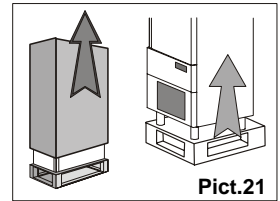

Pict.21

Please quote the product's serial number (shown on the rating plate) on any enquiry to the Manufacturer. **(pict.22)**

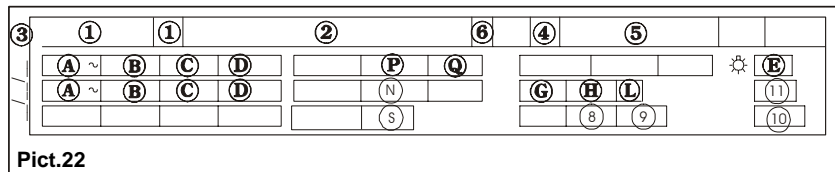

Pict.22

List of rates shown on the rating plate:

- | | |
|---|--|
| <ul style="list-style-type: none"> 1) Model 2) Manufacturer's name and address 3) Date of make 4) Year of make 5) Serial number 6) Power insulation class 8) Maximum pressure of refrigerant 9) Minimum pressure of refrigerant 10) Minimum Circuitry Amp. 11) Max Fuse Size A) Input voltage B) Electric current intensity | <ul style="list-style-type: none"> C) Frequency D) Number phases E) Total lamp power G) Refrigerant type H) Refrigerant quantity L) Class of temperature M) Max hydraulic supply pressure N) Condenser fan current and fans number P) Current rated compressor Q) Locked rotor compressor S) Evaporator fan current and fans number |
|---|--|



MAX ROOM TEMPERATURE (TAB.4)

Air-condenser units should not operate if room temperature is over 100[°F]. Above 90[°F] maximum output is not guaranteed.

POSITIONING

The appliance must be installed and tested in full compliance with accident-prevention regulations contained in national law and current guidelines. Installers are to comply with any current local regulations.

- An omnipolar switch is to be installed before the appliance, in compliance with the current regulations applied in the country where the appliance is installed. **(pict.24)**

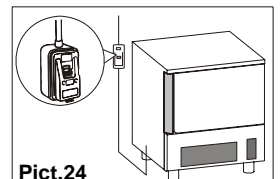

Pict.24

- INSTALLATION MANUAL -

- Do not place the refrigerated compartment near heat sources. (pict.25)

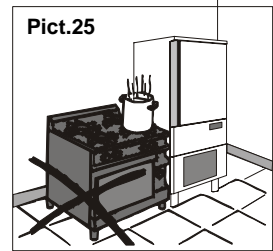

- Remove pvc protective film from all over the appliance. (pict.26)

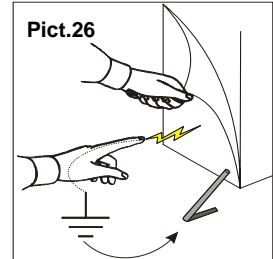

- Place the appliance onto the required working site. (pict.27)

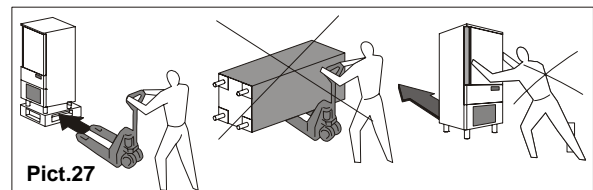

- Avoid locations with exposure to direct sunlight.
- Do not place the appliance in hot, poorly-ventilated rooms.



- Leave a min. 4" clearance around the appliance on the sides where air inlet and outlet are located. (pict.28)

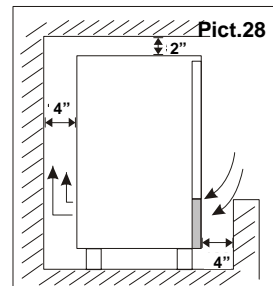

- Level the appliance by means of adjustable feet. (pict.29)

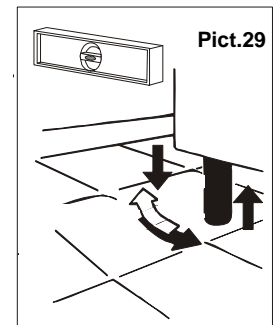

- Use suitable fork lift trucks to level heavier appliances (39[lb] models onwards).

WARNING: If the appliance is not properly levelled the performance and condensate drain may be hampered.

- INSTALLATION MANUAL -

WIRING

The connection to power supply may be carried out at the back of the appliance after removing the protection grid. **(pict.31)**

For remote condensing unit, to make the connection using:
Multipolar wiring made by 11 poles with 4 section AWG 16 and 7 section AWG 12.

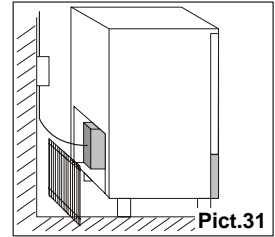

PLEASE USE CERTIFIED APPROVED MATERIALS

All wiring cables are to comply with the ratings shown on the technical specifications.

Cables are to be connected to the equipotential terminal. **(pict.34)**

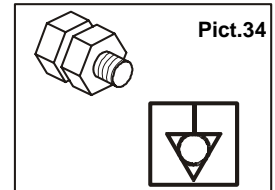

The grounding cable is to be directly connected to a good grounding system. **(pict.35)**

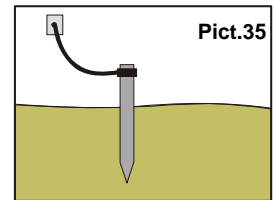

REFRIGERATING CONNECTION

For remote condensing unit, to make the connection in accordance with "Safety Code for Mechanical Refrigeration, ANSI/ASHRAE 15-1989".

Models are to be connected to remote unit condensing using:

High pressure pipe = Copper pipe 3/8" of thickness 1/25.4"

Low pressure pipe = Copper pipe 1/2" of thickness 1/25.4"

Low pressure Pipe connection is to be insulation.



CONNECTION TO CONDENSATE DRAIN

On certain models, a condensation discharge ϕ 1,2" hose installation is necessary, "SAREL" or any similar type). The current general and local regulations as to drains are to be complied with. **(pict.36)**

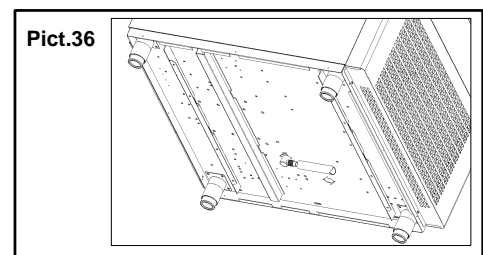

The guarantee will cease and the Manufacturer will not be liable for any damage to appliances or operators arising from the non-compliance with the and tamperings to any part of the appliance (electric, thermodynamic or hydraulic plant).

- INSTALLATION MANUAL -

GENERAL SETTING

TESTING

Carry out the following checkings:

- 1) Outside temperatures must be included between 50[°F] and 110[°F].
- 2) Check power input.
- 3) Carry out at least one full quick cooling cycle

Should the appliance have been transported horizontally instead of a vertical position DO NOT START THE APPLIANCE IMMEDIATELY. WAIT FOR AT LEAST 4 HOURS BEFORE OPERATING.





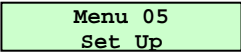
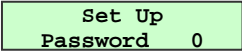
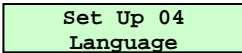
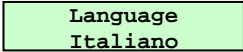

LANGUAGE











	Press the menu key to select the desired menu
	Use the keys up and down to display 
	Press the enter key to gain access to the setting submenus The display shows 
	Use the keys up and down to select the password “-19”
	Press enter to confirm your choice
	Use the keys up and down to display 
	Press enter to display the first language available 
	Use the keys up and down to select the desired language
	Press enter to confirm your choice
	Press menu several times to exit

- INSTALLATION MANUAL -

CLOCK





	Press the menu key to select the desired menu
	Use the keys up and down to display Menu 06 Clock Setting
	Press enter to gain access to the clock setting mode The display shows Date: 06/11/05 Hour: 14:22:46
	Use the keys up and down to change the flashing digit
	Press enter to confirm and pass to the next value
	Press menu several times to exit

TEMPERATURE UNIT OF MEASUREMENT

	Press the menu key to select the desired menu
	Use the keys up and down to display Menu 05 Set Up
	Press the enter key to gain access to the setting submenus The display shows Set Up Password 0
	Use the keys up and down to select the password “-19”
	Press enter to confirm your choice
	Use the keys up and down to display Set Up 03 Parameters
	Press enter to gain access to the parameter programming mode The first parameter is displayed A01 = 23°F Low Alarm
	Use the keys up and down to display parameter D01 D01 = 0



- INSTALLATION MANUAL -

	Press enter to confirm your choice
	Use the keys up and down to select the new value (0 Celsius, 1 Fahrenheit)
	Press enter to confirm your choice
	Press menu several times to exit









PRINTER INSTALLATION

The printer is not supplied as standard equipment .
Should you purchase the printer, please follow the installation instructions to install.





SERVICE FUNCTIONS

CHANGING PARAMETERS



	Press the menu key to select the desired menu
	Use the keys up and down to display Menu 05 Set Up
	Press the enter key to gain access to the setting submenus The display shows Set Up Password 0
	Use the keys up and down to select the password "-19"
	Press enter to confirm your choice
	Use the keys up and down to display Set Up 03 Parameters
	Press enter to gain access to the parameter programming mode The first parameter is displayed A01 = 23°F Low Alarm
	Use the keys up e down to scroll all the controller parameters
	Press enter to confirm your choice

- INSTALLATION MANUAL -

 	Use the keys up e down to select the new value of the parameter
	Press enter to confirm your choice
	Press menu several times to exit

DESCRIPTION OF PARAMETERS

Parameter	Description	Default (IM...)	Default (IR...)	min	MAX
POSITIVE QUICK COOLING					
P01	Room SetPoint in pos. quick cooling, Soft phase	23°F	23°F	-22°F	86°F
P02	SetPoint cella in abbattimento Hard	-13°F	-13°F	-40°F	86°F
P03	Needle SetPoint in pos. quick cooling , Soft phase	38°F	38°F	-22°F	86°F
P04	Needle SetPoint in Hard quick coolong	68°F	68°F	-22°F	86°F
P05	Positive quick cooling duration	90min	90min	0min	900min
P06	Hard phase duration expressed as % in relation to P05	60%	60%	0%	100%
P07	Room SetPoint in pos. storing	36°F	36°F	-22°F	86°F
NEGATIVE QUICK COOLING					
N01	Room SetPoint in neg, quick cooling	-13°F	-13°F	-40°F	86°F
N02	Needle SetPoint in neg. quick cooling	-0°F	-0°F	-22°F	86°F
N03	Negative quick cooling duration	240min	240min	0min	900min
N04	Room SetPoint in neg. storing	-8°F	-8°F	-40°F	86°F
ALARMS					
A01	Temperature alarm hysteresis	36°F	36°F	32°F	122°F
A02	High temperature limit alarm in pos. storing in relation to P07	50°F	50°F	32°F	122°F
A03	Low temperature limit alarm in pos. storing in relation to P07	14°F	14°F	-58°F	32°F
A04	High temperature limit alarm in neg. storing in relation to N04	50°F	50°F	32°F	122°F
A05	Low temperature limit alarm in neg. storing in relation to N04	14°F	14°F	-58°F	32°F
A06	Temperature alarm delay fron storing or defrost start	60min	60min	0min	300min
A07	Temperature alarm delay	30min	30min	0min	300min
A08	Duration of the buzzer in the alarm mode	1min	1min	0min	240min
DISPLAY					
D01	Temperature unit of measurement (0 Celsius; 1 Fahrenheit)	0	0	0	1
D02	Room probe Offset	32°F	32°F	14°F	50°F
D03	BackLight (0 on when pressing a key; 1 always on)	0	0	0	1
DEFROST					
S01	Performs defrost on quick cooling start 0 = No; 1 = Yes	0	0	0	1
S02	End-of-defrost temperature	47°F	47°F	14°F	86°F
S03	Defrost max. duration	15 min	15 min	1 min	90 min
S04	Interval between defrosts in storing (0=excluded)	0 ore	0 ore	0	18 ore
S05	Type of defrost: 0= electrical or due to compressor stop 1= hot gas 2= air	2	2	0	2
S06	Dripping time	1 min	1 min	0 min	90 min
S07	Compressor activation delay with hot gas defrost	0 sec	0 sec	0 sec	600 sec
S08	First defrost activation time from storing start (0=excluded)	0	0	0	90 min
S09	Ignores compressor protection delays in defrost	0	0	0	1



- INSTALLATION MANUAL -

Parameter	Description	Default (IM...)	Default (IR...)	min	MAX
S10	Defrost type started through keyboard: 0= electrical or due to compressor stop 1= hot gas 2= air	0	0	0	2
CONFIGURATION					
C01	Door input (0 de-activated; 1 activated)	1	1	0	1
C02	Door open polarity	0	0	0	1
C03	Door open alarm delay	2 min	2 min	0 min	60 min
C04	Activates buzzer (0 de-activated; 1 activated)	1	1	0	1
C05	Buzzer duration at the end of quick cooling cycle	10 sec	10 sec	0	600 sec
C06	Temperature difference in the first phase of needle insertion test (0 = test excluded)	45°F	45°F	0	140°F
C07	Duration of the second phase of needle insertion test (0=test excluded)	56 sec	56 sec	0	600 sec
C08	Activates condenser probe 0 = no probe 1 = probe	1	1	0	1
C09	Compressor stop delay due to door opening	30 sec	30 sec	0 sec	60 sec
C10	Pressostat alarm detection time	5 sec	5 sec	0 sec	60 sec
C11	High pressure digital input polarity	0	0	0	1
C12	Resistances starting SetPoint	23°F	23°F	14°F	68°F
ADJUSTMENT					
R01	Compressor start/stop hysteresis	38°F	38°F	32°F	68°F
R02	Min. interval between 2 compressor starting	2 min	2 min	0 min	30 min
R03	Compressor start delay from card activation	0 sec	0 sec	0 sec	300 sec
R04	Compressor Duty-Cycle time with faulty room probe in storing	10 min	10 min	0 min	90 min
R05	Compressor ON time faulty room in pos. storing	3 min	3 min	0 min	90 min
R06	Compressor ON time with faulty room in neg. storing	8 min	8 min	0 min	90 min
R07	Needle min. temperature for starting quick cooling	158°F	158°F	32°F	194°F
R08	Compressor inhibition temperature	194°F	194°F	32°F	212°F
R09	Compressor Protection function activation time	24 ore	24 ore	0 ore	240 ore
R10	Pulse duration	2 sec	2 sec	1 sec	10 sec
R11	Pause between pulses	4 sec	4 sec	1 sec	10 sec
R12	Number of pulses	3	3	1	20
FANS					
F01	Evaporator fans activation hysteresis	36°F	36°F	32°F	68°F
F02	Condenser fans activation hysteresis	36°F	36°F	32°F	68°F
F03	Evaporator fans activation SetPoint	41°F	41°F	-58°F	122°F
F04	Condenser fans activation SetPoint	59°F	59°F	-58°F	122°F
F05	Evaporator fans during defrost 0 = fans OFF; 1 = fans ON	0	0	0	1
F06	Condenser fans during defrost 0 = fans OFF; 1 = fans ON	0	0	0	1
F07	Fans stop time after defrost	1 min	1 min	0 min	30 min
F08	Condenser fans stop delay	30 sec	30 sec	0 sec	300 sec
F09	Evaporator fans control during quick cooling: 0 = fans always ON 1 = fans thermostated by evaporator temperature	0	0	0	1
F10	Evaporator fans control during storing: 0 = fans in parallel with the compressor 1 = fans thermostated by evaporator temperature	0	0	0	1
F11	Evaporator fans inhibition temperature	158°F	158°F	32°F	194°F
PRINT					
PR1	Sampling time	10 min	10 min	1 min	60 min









- INSTALLATION MANUAL -

Parameter	Description	Default (IM...)	Default (IR...)	min	MAX
VENTILATION SPEED (P.W.M.)					
CF1	Evaporator fan min. speed	20	20	0	100
CF2	Evaporator fan min. speed selectable in a quick cooling cycle	50	50	0	100
I.F.R.					
B01	Room thermostating temperature in the first phase	-13°F	-13°F	-58°F	122°F
B02	Subcutane T control start temperature	86°F	86°F	-58°F	210°F
B03	First coefficient of the control relation	-2	-2	-50	50
B04	Second coefficient of the control relation	16	16	-50	50
B05	Third coefficient of the control relation	-8	-8	-50	50
B06	Subcutane T initial value determining the end of the first phase	34°F	34°F	-58°F	210°F
B07	Phase two formula coefficient	10	10	0	99
B09	Subcutane t min. value allowed durino the third phase	30°F	30°F	-58°F	210°F
B10	End of intelligent quick cooling core temperature	38°F	38°F	-58°F	210°F
B11	Delay from the positive result of the needle test for starting the procedure to determine the end of the first phase	60 sec	60 sec	0 sec	99 sec
B12	First phase temperature detection time	30 sec	30 sec	0 sec	99 sec
B13	First phase min. duration	6 min	6 min	0 min	99min
B16	Defrost on starting intell. QC cycle (0=no 1=yes)	0	0	0	1
B17	Inhibition temperature	176°F	176°F	-58°F	210°F
B18	Room Set point in the event of automatic switch to time or temperature mode	32°F	32°F	-58°F	210°F
B19	Max. duration possible for intelligent QC process	150 min	150 min	1 min	999 min
B20	Subcutane T safety value determining the end of the first phase	38°F	38°F	-58°F	210°F
B21	First coefficient of the room thermostating curve (third phase)	-25	-25	-90	99
B22	Second coefficient of the room thermostating curve (third phase)	-28	-28	-90	99
B23	Storing activation at the end of intell. QC cycle (0 = no; 1 = yes)	1	1	0	1
B24	Room thermostating Set-point in storing	36°F	36°F	-130°F	194°F
B26	Core temperature limit for the timer start	0	0	0	999
B27	Adjuster of fans speed in the third phase	0	0	0	99
B28	Cold pulse adjuster	0	0	0	99
COMMUNICATION					
ADD	Device Address	1	1	1	147
SC	Serial Control : 0 = not activated 1 = print 2 = ModBus	1	1	0	2
MB1	BaudRate: 0 = 2400; 1 = 4800; 2 = 9600; 3 = 18200	2	2	0	3
MB2	Parity: 0 = no parity; 1 = odd; 2 = even	2	2	0	2
TYPE OF CYCLE					
G01	Positive QC cycles only : 0 = Positive and Negative 1 = Positive only	0	0	0	1



- INSTALLATION MANUAL -

ALARMS AND FAULT ANALYSIS (TAB.5)

	Press the menu key to select the desired menu
	Use the keys up and down to display Menu 08 Alarm
	Press enter to gain access to the mode for displaying alarms If there are no alarms memorized, the display shows No Date If there are alarms memorized, the display shows the last alarm starting time as well as the progressive number ranging from A01 to A30 A05 Err Room S 14:21 15/12/03
	Press enter to get further information about the alarm: The max. or min. temperature, the duration, call SERVICE, the alarm de-activation time or the indication that the alarm is still in progress A05 Err Room Present
	Use the keys up and down to display all the memorized alarms
	Press menu several times to exit



If the fault is not corrected by following the above instructions ask for skilled assistance and avoid carrying out any other operations, especially on the electricals. When informing the servicing company of the fault, state 1 and 5 numbers (pict.37)

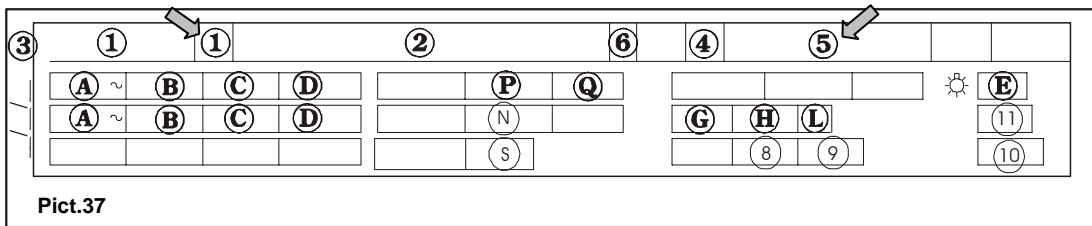

Pict.37





- INSTALLATION MANUAL -

TAB.5

FAULT	CAUSE	REMEDY
No voltage on Anomalous stop	No power supply Blown fuse Loosened connections	Restore power supply Replace fuses Check connection fitting
Compressor failure	High and Low-pressure pressure-switch on Clicker on Contactor failure Compressor thermal relay on	Ask for skilled assistance Ask for skilled assistance Ask for skilled assistance Ask for skilled assistance
The compressor is working but the cabinet is not cooling	Frosted evaporator No coolant inside the refrigerating system Delivery solenoid valve failure	Open the door and carry out defrost cycle Ask for skilled assistance Ask for skilled assistance
Evaporator fans are not working	Fan failure or short-circuit Door micro failure	Ask for skilled assistance Ask for skilled assistance
The cycle cannot start	Wrong cycle programming	Check time and temperature parameters
AL High Press	Pressostat intervention	Qualified technician required
AL Room Probe	Room Probe interrupted	Qualified technician required
AL Evap Probe	Evap Probe interrupted	Qualified technician required
AL Cond Probe	Cond Probe interrupted	Qualified technician required
AL Needle Probe	Needle Probe interrupted	Qualified technician required
AL Insert Needle	Needle Probe not inserted	Check the probe inserting cone
High T Room	Room Temp above set value	If the temperature is not within the specified range, apply to a qualified technician
Low T Room	Room Temp below set value	If the temperature is not within the specified range, apply to a qualified technician
AL BlackOut	No power supply	When power is restored, check the max. temperature reached inside the room
AL Door Open	QC room door open Door micro faulty	Close the door Qualified technician required











DISPLAYING INPUTS/OUTPUTS STATE





	Press the menu key to select the desired menu																				
	Use the keys up and down to display Menu 10 Inputs/Outputs																				
	Press enter to gain access to the mode for displaying inputs and outputs The display shows Room 21°F Needle 59°F																				
	Use the keys up and down to scroll the data to display <div style="display: flex; align-items: flex-start;"> <div style="border: 1px solid black; padding: 2px; margin-right: 10px;">Room 21°F Needle 59°F</div> <div>Room and Needle temperature values</div> </div> <div style="display: flex; align-items: flex-start;"> <div style="border: 1px solid black; padding: 2px; margin-right: 10px;">Evapor. 14°F Condens. 70°F</div> <div>Evaporator and Condenser temperature values</div> </div> <div style="display: flex; align-items: flex-start;"> <div style="border: 1px solid black; padding: 2px; margin-right: 10px;">C D FE FC L R A 1 0 0 1 1 0 0</div> <div> Outputs state 1 = relay activated 0 = relay de-activated </div> </div> <div style="display: flex; align-items: flex-start;"> <div style="border: 1px solid black; padding: 2px; margin-right: 10px;">DI1 DI2 FAN 0 1 80</div> <div> Digital inputs state and evaporator fan speed </div> </div> <table border="1" style="font-size: small; border-collapse: collapse;"> <tr> <td>C</td><td>Compressor</td><td>R</td><td>Door resistance</td> </tr> <tr> <td>D</td><td>Defrost</td><td>A</td><td>Alarm</td> </tr> <tr> <td>FE</td><td>Evaporator fan</td><td>DI1</td><td>Inputs state micro</td> </tr> <tr> <td>FC</td><td>Condenser fan</td><td>DI2</td><td>Inputs state thermostat</td> </tr> <tr> <td>L</td><td>Sterilisation</td><td>FAN</td><td>Evaporator fan speed</td> </tr> </table>	C	Compressor	R	Door resistance	D	Defrost	A	Alarm	FE	Evaporator fan	DI1	Inputs state micro	FC	Condenser fan	DI2	Inputs state thermostat	L	Sterilisation	FAN	Evaporator fan speed
C	Compressor	R	Door resistance																		
D	Defrost	A	Alarm																		
FE	Evaporator fan	DI1	Inputs state micro																		
FC	Condenser fan	DI2	Inputs state thermostat																		
L	Sterilisation	FAN	Evaporator fan speed																		
	Press menu several times to exit																				

- INSTALLATION MANUAL -







DISPLAYING THE LATEST DEFROST CYCLES

	Press the menu key to select the desired menu
	Use the keys up and down to display Menu 05 Set Up
	Press the enter key to gain access to the setting submenus The display shows Set Up Password 0
	Use the keys up and down to select the password “-19”
	Press enter to confirm your choice
	Use the keys up and down to display Set Up 01 Defrost
	Press enter to gain access to the mode for displaying the latest 32 defrost cycles If there are no defrost cycles memorized, the display shows No Date
	As for the memorized cycles, the display shows the starting time and date, the duration expressed in minutes, and the corresponding progressive number ranging from D01 to D32 <div style="border: 1px solid black; padding: 2px; display: inline-block; margin-top: 5px;">D09 22Min M=03 S 11:44 10/12/03</div> <small>Where M indicates the type of defrost start: M = 1 defrost started through the keyboard during storing. M = 2 periodic defrost in storing . M = 3 defrost started on the quick cooling starting</small>
	Use the keys up and down to display all the memorized defrost cycles
	Press menu several times to exit

DISPLAYING DOOR OPENINGS







	Press the menu key to select the desired menu
	Use the keys up and down to display Menu 05 Set Up
	Press the enter key to gain access to the setting submenus The display shows Set Up Password 0

- INSTALLATION MANUAL -



	Use the keys up and down to select the password “-19”								
	Press enter to confirm your choice								
	Use the keys up and down to display <div style="border: 1px solid black; padding: 2px; display: inline-block; margin-left: 20px;"> Set Up 02 Door Open </div>								
	Press enter to gain access to the mode for displaying the door opening records during a quick cooling of the last day. The controller allows to record up to 31 days. Each operating day is allotted a memory cell where the total number of door openings is recorded, along with the door openings exceeding a duration of C03 minutes and the total time of door opening. The memory capacity allows to record up to 31 days. Parameter C01, if other than zero, activates the door micro input. <table style="width: 100%; border-collapse: collapse; margin-top: 10px;"> <tr> <td style="width: 50%; text-align: center;">Day and month of record</td> <td style="width: 50%; text-align: center;">Door openings total</td> </tr> <tr> <td style="text-align: center;">05/11</td> <td style="text-align: center;">01h34m</td> </tr> <tr> <td style="text-align: center;">long:01</td> <td style="text-align: center;">tot:03</td> </tr> <tr> <td style="text-align: center;">Number of door openings exceeding parameter C03</td> <td style="text-align: center;">Total number of door</td> </tr> </table>	Day and month of record	Door openings total	05/11	01h34m	long:01	tot:03	Number of door openings exceeding parameter C03	Total number of door
Day and month of record	Door openings total								
05/11	01h34m								
long:01	tot:03								
Number of door openings exceeding parameter C03	Total number of door								
	For the records relating to the other days use the keys up and down.								
	Press menu several times to exit								



ALARMS AND USER PROGRAMMES CANCELLATION











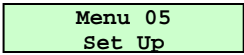

	Press the menu key to select the desired menu
	Use the keys up and down to display <div style="border: 1px solid black; padding: 2px; display: inline-block; margin-left: 20px;"> Menu 05 Set Up </div>
	Press the enter key to gain access to the setting submenus The display shows <div style="border: 1px solid black; padding: 2px; display: inline-block; margin-left: 20px;"> Set Up Password 0 </div>
	Use the keys up and down to select the password “-19”
	Press enter to confirm your choice
	Use the keys up and down to display <div style="border: 1px solid black; padding: 2px; display: inline-block; margin-left: 20px;"> Set Up 05 Reset Memory </div>
	Press enter to gain access to the mode for cancelling the data stored in the memory The display shows <div style="border: 1px solid black; padding: 2px; display: inline-block; margin-left: 20px;"> Reset Memory? No Ok </div>

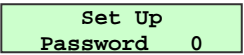
- INSTALLATION MANUAL -

	Press Up to cancel the whole memory
	Press menu several times to exit

RESTORING PRE-SET PARAMETERS

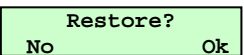
ATTENTION: should you use the device with the “RESTORE” option, available on the card, please apply to the manufacturer for proper setting of the electronic controller configuration parameters.

	Press the menu key to select the desired menu
	Use the keys up and down to display 
	Press the enter key to gain access to the setting submenus The display shows 
	Use the keys up and down to select the password “-19”
	Press enter to confirm your choice
	Use the keys up and down to display 
	Press enter to gain access to the mode for cancelling the data stored in the memory The display shows 
	Press Up to cancel the whole memory
	Press menu several times to exit



- INSTALLATION MANUAL -

MAINTENANCE OF PANEL BOARD

The following operations are to be carried out by skilled staff only.

Turn the mains switch OFF. (**pict.38**)

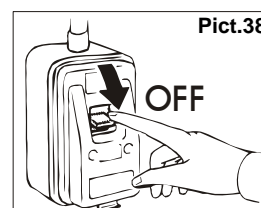

Disconnect the plug. (**pict.39**)

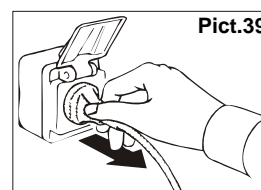

To be able to access the electric picture:

Mod. 22lb

Remove the front panel (**pict.40**) with a tool and move the electric board box (**pict.41**) along the slides

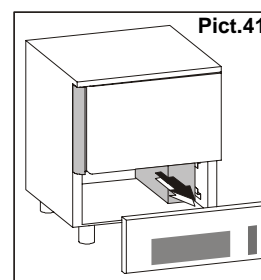
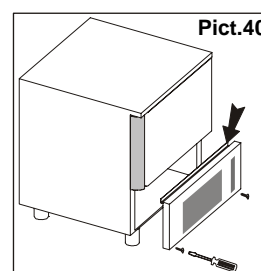

Remove the electrical board cover with a tool to access the internal components. Two delayed fuses are inserted in the power supply line. For replacement remove the cover by unscrewing the fixing screws, extract the blown fuse and replace it with a fuse having the same characteristics. (**pict.42**)

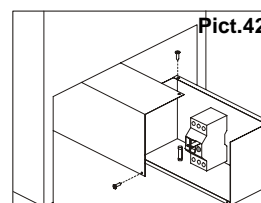

Mod. 44lb-66lb-88lb

Remove the front panel (**pict.43**) and the control panel by means of a suitable tool.

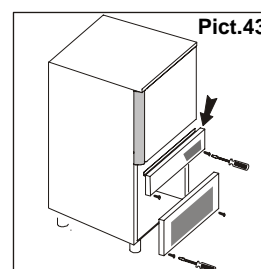

Remove the cover to have access to the components using a suitable tool (**pict.44**).

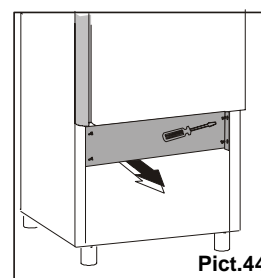

- INSTALLATION MANUAL -

Two delayed fuses are inserted in the power supply line;
extract the blown fuse and replace it with a fuse having the same characteristics.
(pict.45)

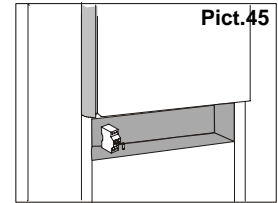

WIRING DIAGRAM PLATE

The diagram is shown on pict.47.

CONTROL AND SAFETY SYSTEMS

The following information concerns skilled staff only:

- **Door micro-switch:** Prevents the appliance from working when the door is open
- **Overall protection fuses:** Protect the whole power circuit from and short-circuits and overloads
- **Compressor thermal relay:** Operates in case of an overload or working failures
- **Motor-fan thermal relay:** Operates in case of an overload or working failures
- **Safety pressure-switch:** Operates in case of coolant over-pressure
- **Cabinet temperature control:** Is run by NTC probe through the relevant electronic card
- **Core temperature control:** Is run by PT100 probe through an electronic card
- **Controlled substances leakage:** appliances with a content of coolant exceeding 7lb should be checked for leakage yearly



DISPOSAL

WASTE STORAGE

Appliances that have reached the end of their service life should be suitably disposed of. The doors should be removed before disposal. Temporary storage of special waste is permitted while waiting for disposal by treatment and/or final collection. Dispose of special waste in accordance with the laws in force with regard to protection of the environment in the country of the user.

PROCEDURE FOR ROUGH DISMANTLING THE APPLIANCE

All countries have different legislation; provision laid down by the laws and the authorised bodies of the countries where the demolition takes place are therefore to be observed. A general rule is to deliver the appliance to specialised collection and demolition centres. Dismantle the refrigerator grouping together the components according to their chemical nature. The compressor contains lubricating oil and refrigerant, which may be recycled. The refrigerator components are considered special waste, which can be assimilated with domestic waste. Make the appliance totally unusable by removing the power cable and any door locking mechanisms in order to avoid the risk of anyone being trapped inside.

DISMANTLING OPERATIONS SHOULD BE CARRIED OUT BY QUALIFIED PERSONNEL.

- INSTALLATION MANUAL -

REFRIGERANT MATERIAL SAFETY DATA SHEET

R134a

GWP = 1300

ODP = 0

R404a: fluid components

trifluoroethane	(HFC 143a)	52%
pentafluoroethane	(HFC 125)	44%
tetrafluoroethane	(HFC 134a)	4%

GWP = 3750

ODP = 0

Hazard identification

Overexposure through inhalation may cause anaesthetic effects. Acute overexposure may cause cardiac rhythm disorders and sudden death. Product mists or sprays may cause ice burns of eyes and skin.

First aid procedures

• Inhalation:

keep injured person away from exposure, warm and relaxed. Use oxygen, if necessary. Give artificial respiration if respiration has stopped or is about to stop. In case of cardiac arrest give external cardiac massage. Seek immediate medical attention.

• Skin:

use water to remove ice from affected areas. Remove contaminated clothes.

CAUTION: clothes may adhere to skin in case of ice burns.

In case of contact with skin, wash with copious quantities of lukewarm water. In case of symptoms (irritation or blisters) seek medical attention.

• Eyes:

immediately wash with ocular solution or fresh water, keeping eyelids open for at least 10 minutes. Seek medical attention.

• Ingestion:

it can cause vomit.. If conscious, rinse mouth with water and drink 200-300 ml of water. Seek medical attention.

• Other medical treatment:

symptomatic treatment and support therapy when indicated. Do not administer adrenaline or sympatheticomimetic drugs after exposure, due to the risk of arrhythmia and possible cardiac arrest.

Environmental data

Persistence and degradation

• HFC 143a:

slow decomposition in lower atmosphere (troposphere). Duration in atmosphere is 55 years.

• HFC 125:

slow decomposition in lower atmosphere (troposphere). Duration in atmosphere is 40 years.

• HFC 134a:

relatively rapid decomposition in lower atmosphere (troposphere). Duration in atmosphere is 15.6 years.

• HFC 143a, 125, 134a:

does not affect photochemical smog (not included in volatile organic components – VOC – as established in the UNECE agreement). Does not cause ozone rarefaction.

PRODUCT EXHAUSTS RELEASED IN THE ATMOSPHERE DO NOT CAUSE LONG-TERM WATER CONTAMINATION.



- INSTALLATION MANUAL -

DIMENSIONS

Please refer to the dimensions of your own appliance.

**IM51M
IR51M**

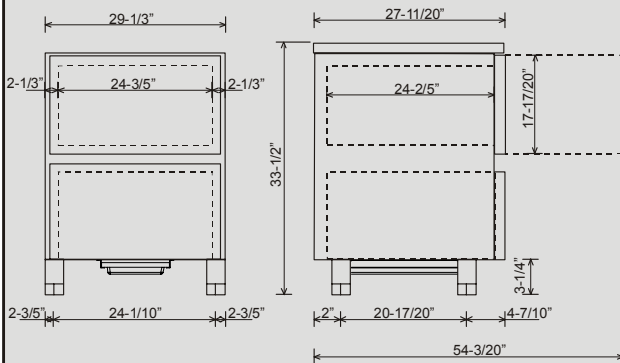

**IM51C
IR51C**

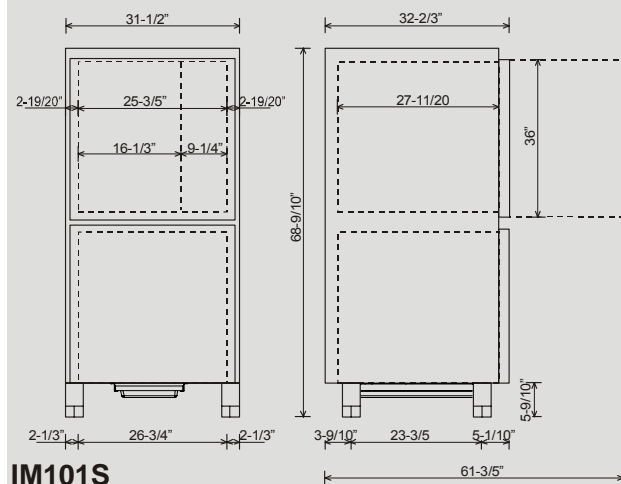
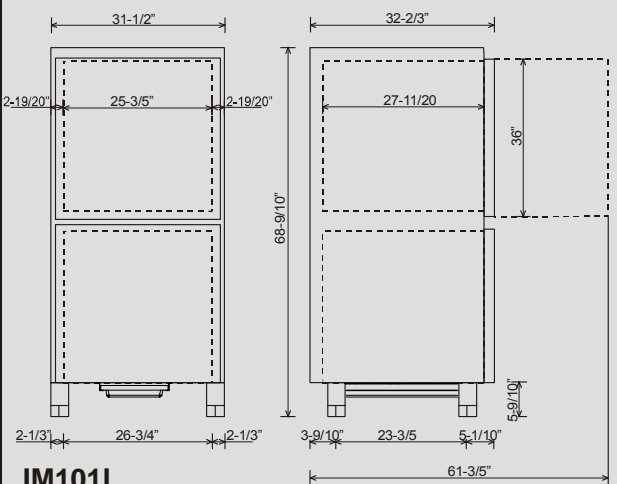
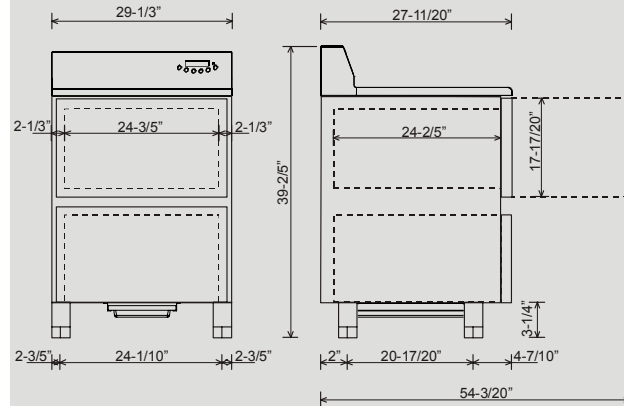

**IM101L
IR101L**

**IM101S
IR101S**

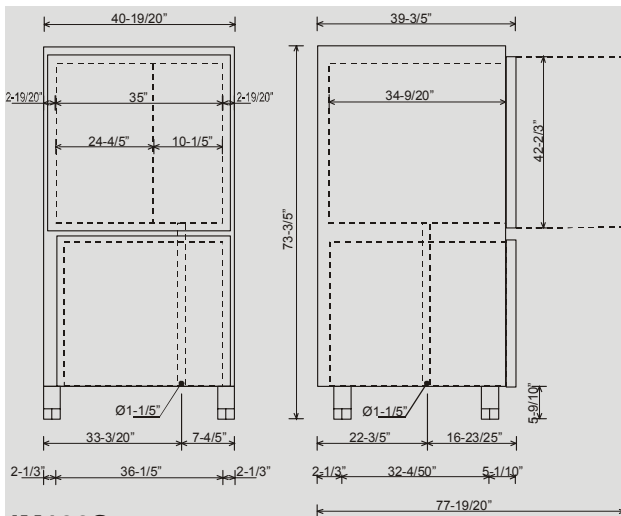
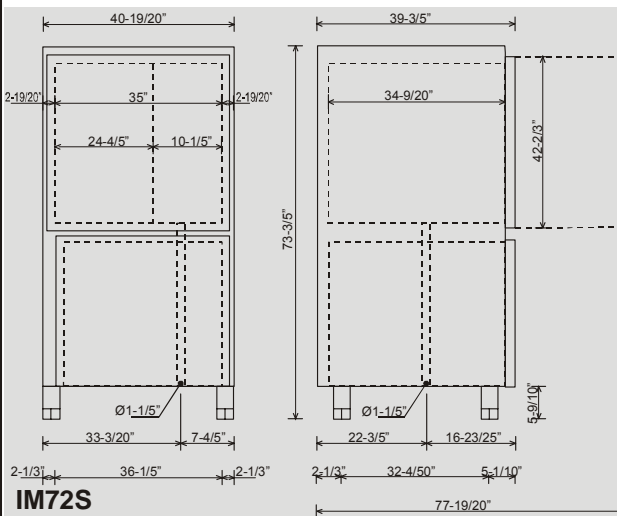

**IM72S
IR72S**

IM102S



- INSTALLATION MANUAL -

ANNEXES

TAB.1a

Model	IM51M-IM51C (22lb)	IM101L (44lb L)	IM101S (44lb S)	IM72S (66lb)	IM102S (88lb)
Gross weight [lb]	276	485	485	551	706
Net weight [lb]	254	430	430	485	640
Dimensions	29,3x27,5 x33,5/39,4	31,5x32,7 x68,9	31,5x32,7 x68,9	40,9x39,6 x73,6	40,9x39,6 x73,6
Capacity					
Mass /cycle [lb]	22	44	44	55	88
Internal volume [cuft]	2,55	5,52	5,52	13,58	13,58
Rails	GN1/1 20,8x15,75	GN1/1 20,8x15,75	GN1/1 20,8x15,75	GN2/1 20,8x31,5	GN2/1 20,8x31,5
Trays	3	6	6	6	10
Power supply					
Voltage [V]	220 ~	220 ~	220 ~	220 ~	220 ~
Frequency [Hz]	60	60	60	60	60
Intensity [A]	5,5	12,5	12,5	13,3	17
Phase	1 ph	3 ph	3 ph	3 ph	3 ph
Refrigerating unit					
Refrigerating power [W]	617	2011	2011	2011	2400
Evaporation temperature [°F]	-22	-22	-22	-22	-22
Cooling temperature [°F]	+194÷+38	+194÷+38	+194÷+38	+194÷+38	+194÷+38
Cooling time [min]	90	90	90	90	90
Freezing temperature [°F]	+194÷0	+194÷0	+194÷0	+194÷0	+194÷0
Freezing time [min]	240	240	240	240	240
Condensation temperature [°F]	+130	+130	+130	+130	+130
Max room temperature [°F]	+90	+90	+90	+90	+90
Compressor type	Ermetic	Ermetic	Ermetic	Ermetic	Ermetic
Fluid refrigerant	R404a	R404a	R404a	R404a	R404a
Fluid refrigerant qty [lb]	3	4,4	4,4	5	7,7
Condesation air	Air	Air	Air	Air	Air
Noise [dB] (A)	65	72	72	72	72
IFR	•	•	•	•	•
Multi-detector probe	•	•	•	•	•

Cooling time increases by 20% if the machine is leaning against the wall.

- INSTALLATION MANUAL -

TAB.1b

Model	IR51M-IR51C (22lb)	IR101L (44lb L)	IR101S (44lb S)	IR72S (66lb)
Gross weight [lb]	276	485	485	551
Net weight [lb]	254	430	430	485
Dimensions	29,3x27,5 x33,5/39,4	31,5x32,7 x68,9	31,5x32,7 x68,9	40,9x39,6 x73,6
Capacity				
Mass /cycle [lb]	22	44	44	55
Internal volume [cuft]	2,55	5,52	5,52	13,58
Rails	GN1/1 20,8x15,75	GN1/1 20,8x15,75	GN1/1 20,8x15,75	GN2/1 20,8x31,5
Trays	3	6	6	6
Power supply				
Voltage [V]	220 ~	220 ~	220 ~	220 ~
Frequency [Hz]	60	60	60	60
Intensity [A]	3,5	5	5	6
Phase	1 ph	3 ph	3 ph	3 ph
Refrigerating unit				
Refrigerating power [W]	692	2245	2245	3325
Evaporation temperature [°F]	14	14	14	14
Cooling temperature [°F]	+194÷+38	+194÷+38	+194÷+38	+194÷+38
Cooling time [min]	90	90	90	90
Freezing temperature [°F]	-	-	-	-
Freezing time [min]	-	-	-	-
Condensation temperature [°F]	+130	+130	+130	+130
Max room temperature [°F]	+90	+90	+90	+90
Compressor type	Ermetic	Ermetic	Ermetic	Ermetic
Fluid refrigerant	R404a	R404a	R404a	R404a
Fluid refrigerant qty [lb]	2,2	4	4	4,4
Condesation air	Air	Air	Air	Air
Noise [dB] (A)	65	72	72	72
IFR	•	•	•	•
Multi-detector probe	•	•	•	•

Cooling time increases by 20% if the machine is leaning against the wall.

TAB.4

Min. air circulation

Model	Air q.ty [cfm]
22 lb	650
44 lb	2.060
66 lb	2.530
88 lb	5.300

- INSTALLATION MANUAL -

Pict.47

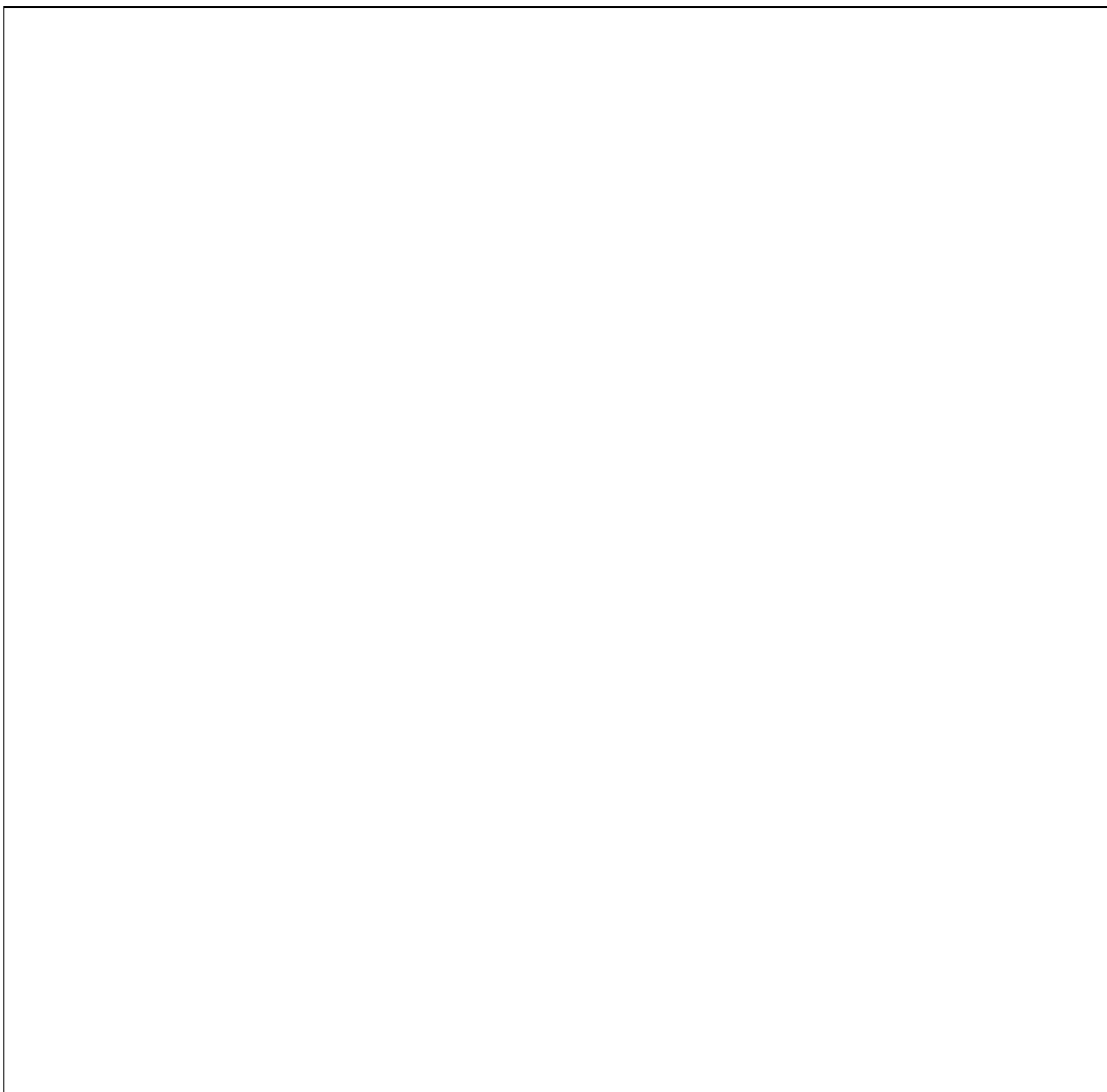

N°	DESCRIPTION	N°	DESCRIPTION
1	COMPRESSOR	76	DOOR MICRO-SWITCH
2	CONDENSER FAN MOTOR	77	ROOM PROBE
2A	CONDENSER FAN MOTOR TERMOST.	78	EVAPORATOR/DEFROST PROBE
3	SUPPLY TERMINAL BLOCK	79A	MULTIPOINT CORE PROBE
3A	TERMINAL BLOCK	80	COMPRESSOR PTC RESISTOR
9	EVAPORATOR FAN MOTOR	85A	JUNTION BOX WITH TERMINALBLOCK (EVAP.)
9A	EVAPORATOR FAN MOTOR	85B	JUNTION BOX WITH TERMINALBLOCK (COND.)
20	ANTI-CONDENSATION DOOR HEATER	86	CONDENSER PROBE
44	RELAY FINDER	87	RUN CAPACITOR FORCONDENSER FAN MOTOR 4µF
65	CONTACTOR	87A	RUN CAPACITOR FOR CONDENSERFAN MOTOR TERMOST.4µF
66	SOLID STATE OVERLOAD RELAY	88	DOOR HEATER TRANSFORMER
67	RUN CAPACITOR FOR EVAPORATOR FAN MOTOR 8µF	89	2 FUSE-HOLDER +2 FUSES OFPROTECTION TRANSFORMER
67A	RUN CAPACITOR FOR EVAPORATOR FAN MOTOR 8µF	92	PRINTER PM100A
69	TERMINAL GROUND	94	DISCONNECTOR
70	HIGH PRESSURE LIMIT SWITCH	96	2 FUSE-HOLDER + 2 FUSES
70A	LOW PRESSURE LIMIT SWITCH	97	MOTHER BOARD AND CONTROL PANEL
73	3 FUSE-HOLDER + 3 FUSES	97A	FASEC
75	AUXILIARY VALVE		

