

## TABLE OF CONTENTS

	PAGE
FOREWARD	1
TABLE OF CONTENTS	2
SPECIFICATIONS	
Mechanical Specifications	3
Continuous Flow-Capacity Chart	4
Specifications Chart	5
Storage Type-Capacity Chart	6
Specifications-Chart	7
How It Works	8
INSTALLATION	
Preparation for Installation	9
Selection of Location	10
Installation Practice	11
Installation-Electrical	12
Refrigeration Cycle	13
Water Schematic	14
Wiring Diagram-Air Cooled	15
Wiring Diagram-Water Cooled	16
Final Check List	17
SERVICE	
Starting the Machine	18
Refrigerant Charge	18
Water System	19
Electrical System	19-20
Removal and Installation of Parts	21-24
Chassis-Front View-Water Cooled	25
Chassis-RearView-Water Cooled	26
Chassis-Front View-Air Cooled	27
Chassis-Rear View-Air Cooled	28
Freezer Assembly	29
Reservoir Assembly	30
Gear Motor Assembly	31
Case and Hood Assembly	32
Case Assembly	33
Service Analysis	34-35
Maintenance Instructions	36-37
Parts List	38-40

**THIS PAGE  
INTENTIONALLY  
LEFT BLANK**

**THIS PAGE  
INTENTIONALLY  
LEFT BLANK**

MECHANICAL SPECIFICATIONS

	SF-1WSJ	SF-1WWSJ
Compressor	1/2 HP Copelaweld	Same
Condenser	Air Cooled	Water Cooled
Refrigerant	26 oz. R 12	24 oz. R 12
Refrigerant Control	Capillary Tube	Same
Power Consumption - Compressor	11.0 Amps.	Same
Power Consumption - Gear Motor	4.0 Amps.	Same
Current	115 V, 60 cycle, 1 Ph..	Same
Gear Motor Drive	1/10 HP	Same
Worm - R.P.M.	10.5	Same
Water Consumption - Freezer	2.5 Gallons per hour	Same
Water Consumption - Condenser		Varies from .75 to 2 G.P.M.
<b>CABINET DIMENSIONS</b>	<b>SF1J</b>	<b>SF1WSJ</b>
Width	17 7/8"	38 1/2"
Depth	24 1/2"	24 1/2"
Height	40"	40"
Height with 6" legs	46"	46"
<b>SHIPPING WEIGHT</b>		
Approx. shipping weight	220	314

# SCOTSMAN®

## SUPER FLAKER SF-1 SERIES Continuous Flow

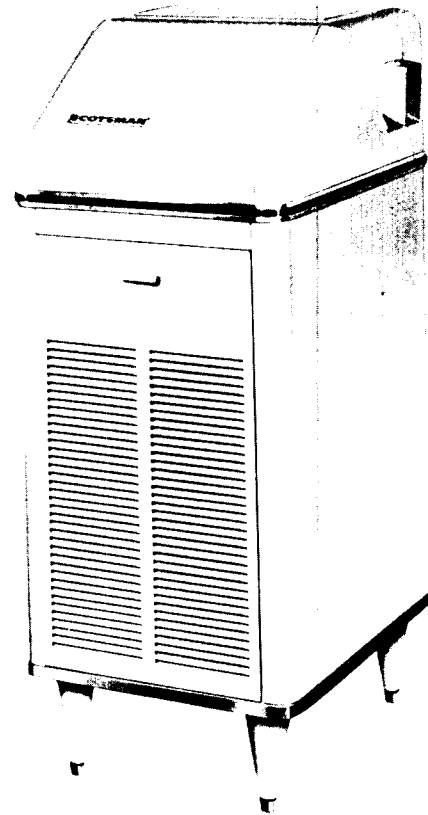

ice making capacity

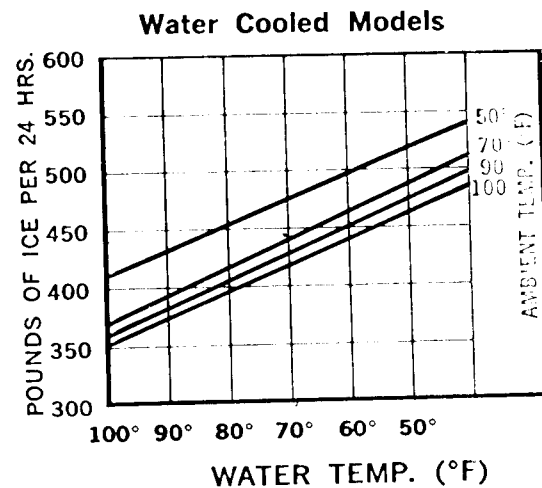
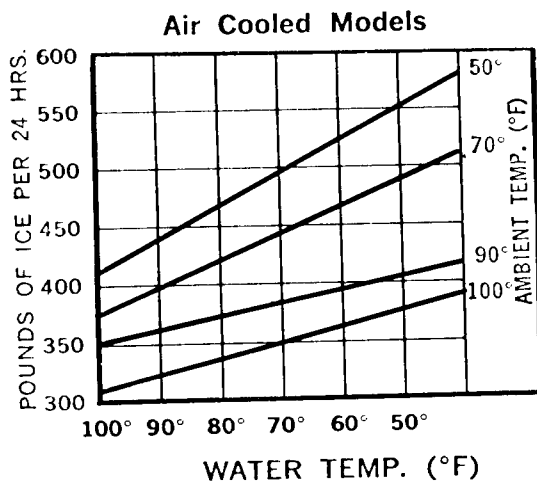

# SPECIFICATIONS

## SUPER FLAKER SF-1 SERIES (Cont. Flow)

	MODEL SF-1J	MODEL SF-1WJ
Daily capacity up to 500 lbs.	X	X
Air cooled condenser	X	
Water cooled condenser		X
Heavy duty 1/2 HP. Compressor	X	X
Standard 115 V, 60 cy, 1 ph	X	X
1/4" water inlet SAE Flare	X	X
3/8" water inlet NPT		X
3/8" water condensate drain ID	X	X
3/8" ID water outlet tube		X
Hammerloid grey exterior	X	X
Stainless steel exterior		
46" to 46 3/4" height (with legs)	X	X
40" height (without legs)	X	X
17 7/8" width	X	X
24 1/2" depth	X	X
Shipping weight	220	223

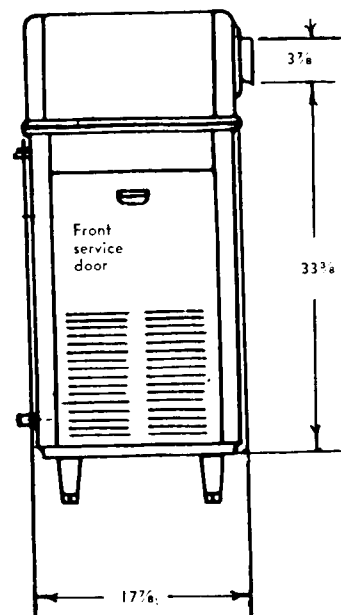
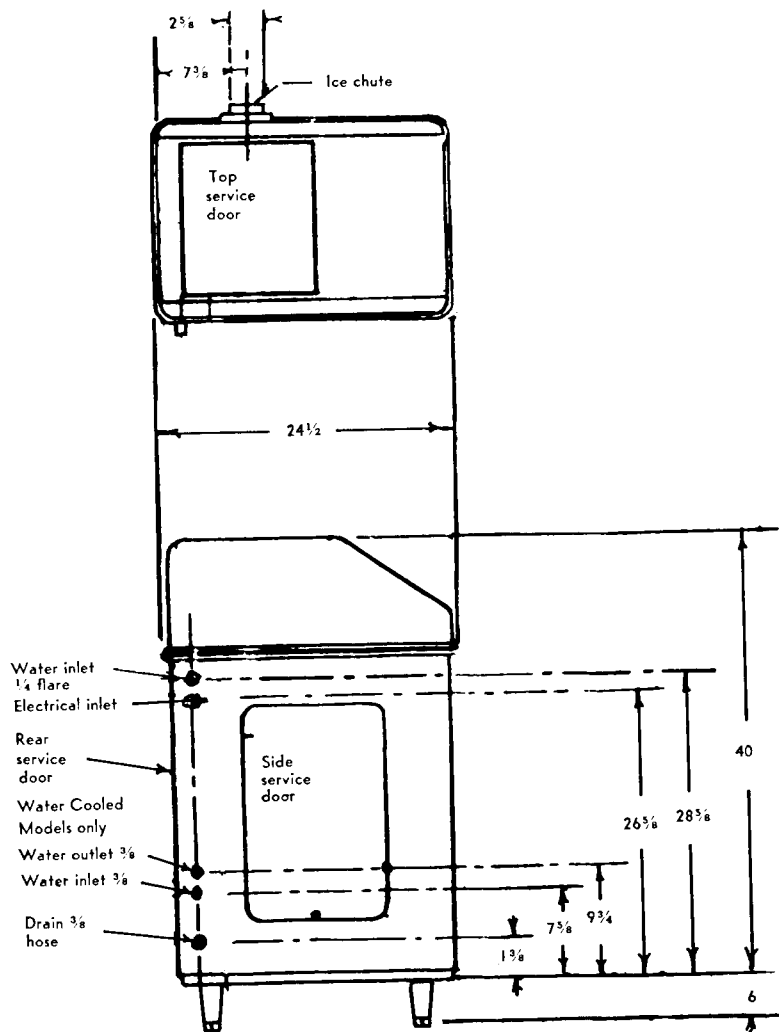

# SCOTSMAN®

## SUPER FLAKER SF-1 SERIES Storage Type

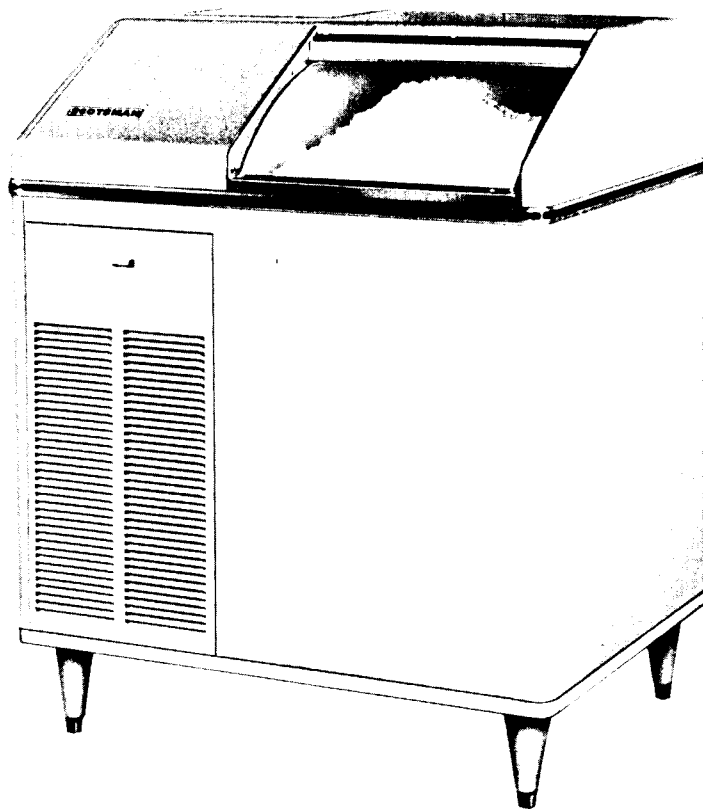

ice making capacity

Air Cooled Models

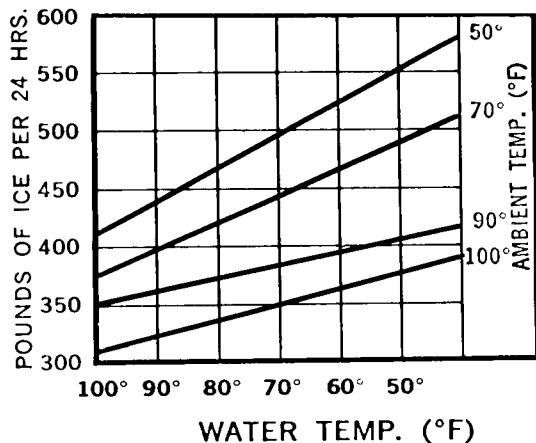

Water Cooled Models

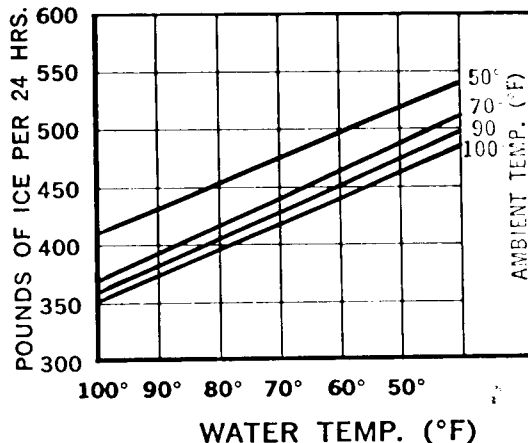

# SPECIFICATIONS

SUPER FLAKER SF-1WSJ SERIES (Storage Type)	MODEL SF-1WSJ	MODEL SF-1WWSJ	MODEL SF-1WSJ-SS	MODEL SF-1WWSJ-SS
Daily capacity up to 500 lbs.	X	X	X	X
200 lb. ice storage bin	X	X	X	X
Stainless steel bin	X	X	X	X
Air cooled condenser	X		X	
Water cooled condenser		X		X
Heavy Duty 1/2 HP. Compressor	X	X	X	X
Standard 115 V, 60 cy, 1 ph,	X	X	X	X
1/4" water inlet SAE Flare	X	X	X	X
3/8" water inlet NPT		X		X
5/8" bin drain OD	X	X	X	X
3/8" water outlet OD		X		X
Hammerloid grey exterior	X	X		
Stainless steel exterior			X	X
46" to 46 3/4" height (with legs)	X	X	X	X
40 height (without legs)	X	X	X	X
38 1/2" width	X	X	X	X
24 1/2" depth	X	X	X	X
Shipping weight	314	317	317	320

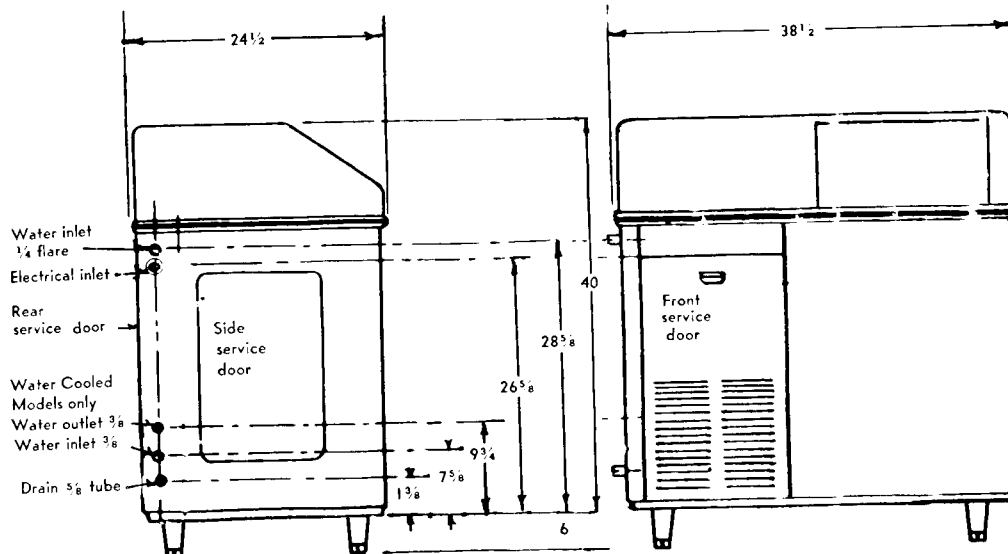
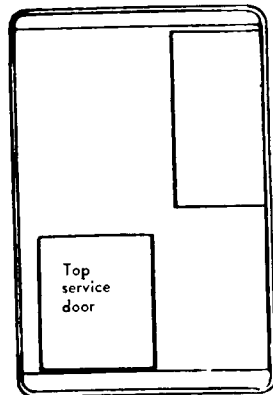



## SPECIFICATIONS

SCOTSMAN Super Flakers are designed for restaurants, super markets, soda fountains, hospitals, bakeries, fish markets, poultry stores, packing plants, etc. It is the finest Ice Maker on the market today. It will work 24 hours a day for you, or only as needed. It produces the highest quality ice available at any price.

Approximately 500 pounds of SCOTSMAN crushed ice is delivered each 24 hours to the storage bin for immediate use.

SCOTSMAN Super Flakers are easily installed requiring only standard water, drain and electrical connections.

ATTRACTIVE COMPACT CABINET. Grey hammerloid finish with chrome trim, rounded corners, and removable panels for easy access to mechanical parts. Adjustable and removable legs are under cabinet.

SEALED REFRIGERATION SYSTEM. Provides quiet, efficient operation of the machine. Compressor motor is internally spring mounted for quiet operation. Compressor motor is covered by a full 5-Year Warranty.

HOW IT WORKS. An exclusive patented ice-making system, wherein water in the constant level float reservoir is fed to the bottom end of the freezing cylinder and turns to ice on the inside of this cylinder. Ice from the refrigerated walls of this cylinder is extruded past the ice breaker at the top of the cylinder through a side opening by means of a stainless steel auger driven by a gearmotor drive.

All SCOTSMAN Models SF1J and SF1WSJ are completely automatic. A manual switch on the front starts the machine, and from then on, produces flakes automatically. When the storage bin fills, the machine automatically shuts off and starts up again when ice is taken from the storage compartment.

Model No. SF1J is a continuous flow type machine, and is manually started by an OFF and ON switch located on the front of the cabinet as are the SF-1WSJ models. Since the SF-1J does not have its own attached bin, it is necessary to use an auxillary bin such as the Model SB-500 SCOTSMAN Super Bin for ice storage. A bin thermostat is mounted in each SF-1J continuous flow type machine for the purpose of mounting control bulb from machine to bin.

## SCOTSMAN SUPER FLAKERS PREPARATION FOR INSTALLATION

### 1. UNCRATING

The entire unit comes in one crate. Upon delivery a visual inspection of the crate should be made and any severe damage noted should be reported to the delivering carrier and a concealed damage claim filed subject to internal inspection with carrier representative present. Remove crate by pulling nails driven through sides of crate into the bottom skid. A nail puller is best suited here. Next remove (4) four bolts from underside of skid which connect to complete unit base. Unit now free from all crating.

2. Remove all service doors and panels.
3. Remove water reservoir cover and take out paper packing around float ball.
4. Remove leg packages in compartment base and install 4 legs in unit base sockets. On continuous flow models with separate storage bins, legs are put on companion machine stand, not on Ice Maker.
5. Check motor compressor hold down nuts to insure motor compressor rides snug on mounting pads.
6. Remove water strainer from storage bin for installation on unit or in water supply line feeding unit.
7. Open electrical control box and prepare for hook up, use knock outs, cord connectors etc. Then check unit nameplate voltage against building source voltage and make sure they correspond. Caution - Improper voltage supplied to units will void your warranty protection.
8. Select unit location prior to hook up of water drain and electricals in accordance with local and national codes. Minimum room temperatures is 50° Fahrenheit. On air cooled models, select well ventilated location.
9. Remove warranty card and Users manual from storage bin, then wipe bin clean with damp cloth.
10. Fill out warranty card completely including model and serial numbers; as taken from aluminum plate found behind front service panel and forward to Scotsman Factory using self mailing card.
11. Level unit with adjustable legs.

## SELECTING LOCATION

**UNDER BAR INSTALLATIONS:** Locate, if possible, so left end panel is accessible. Locate so proper circulation can be attained around the unit and behind it at least four inches.

**KITCHEN INSTALLATIONS:** As a rule, the kitchen is not the most practical place to install an air-cooled condensing unit, as grease is almost always present and makes cleaning of the condensing unit difficult. Do not locate near range or steam table or other heating devices that may be used in the kitchen..

**STOREROOM INSTALLATIONS:** Be sure storeroom is of adequate size and properly ventilated. A small, poorly ventilated room will greatly impair the efficiency of the unit. The storeroom must be kept above 50 degrees in the winter months.

**BASEMENT INSTALLATIONS:** Locate machine in the coolest place. Locate machine in a dry place. Keep away from furnace and boiler room. Keep away from service chutes and runways; also coal or other dust of any kind. If the machine is set over a floor drain, block the machine up enough to level it. If there is any chance of basement flooding, block the machine up enough to eliminate any possible damage to the machine.

**WATER SUPPLY:** The recommended water supply line is 1/4 inch I.D. copper tubing for SF-1. Connect to cold water supply line with regular plumbing fittings, with a shut-off valve installed in an accessible place between supply line and machine. A water strainer must be installed with the unit and mounted with clean-out plug down. Locate the strainer next to the machine with the arrow in the direction of the flow. Most plumbing codes also call for double check valves in the supply water line, particularly for water-cooled models.

On air-cooled models the water supply line connects to the 1/4 inch flare fitting on the machine. On water-cooled models connections are made to a 3/8 inch male pipe nipple inside of the machine compartment. Incoming water goes through the water regulating valve first and then to the water-cooled condenser. Observe arrow on water regulating valve. Water supply must be installed to conform with local code. In some cases a licensed plumber and/or a plumbing permit will be required.

**DRAIN:** The recommended drain from the bin is 5/8 inch OD copper tubing. Must be run to an open trapped and vented drain. If drain is a long run, allow 1/4 inch pitch per foot. Drain must be installed to conform with local code. Run separate line for condenser discharge water on water-cooled models.

INSTALLATION PRACTICE

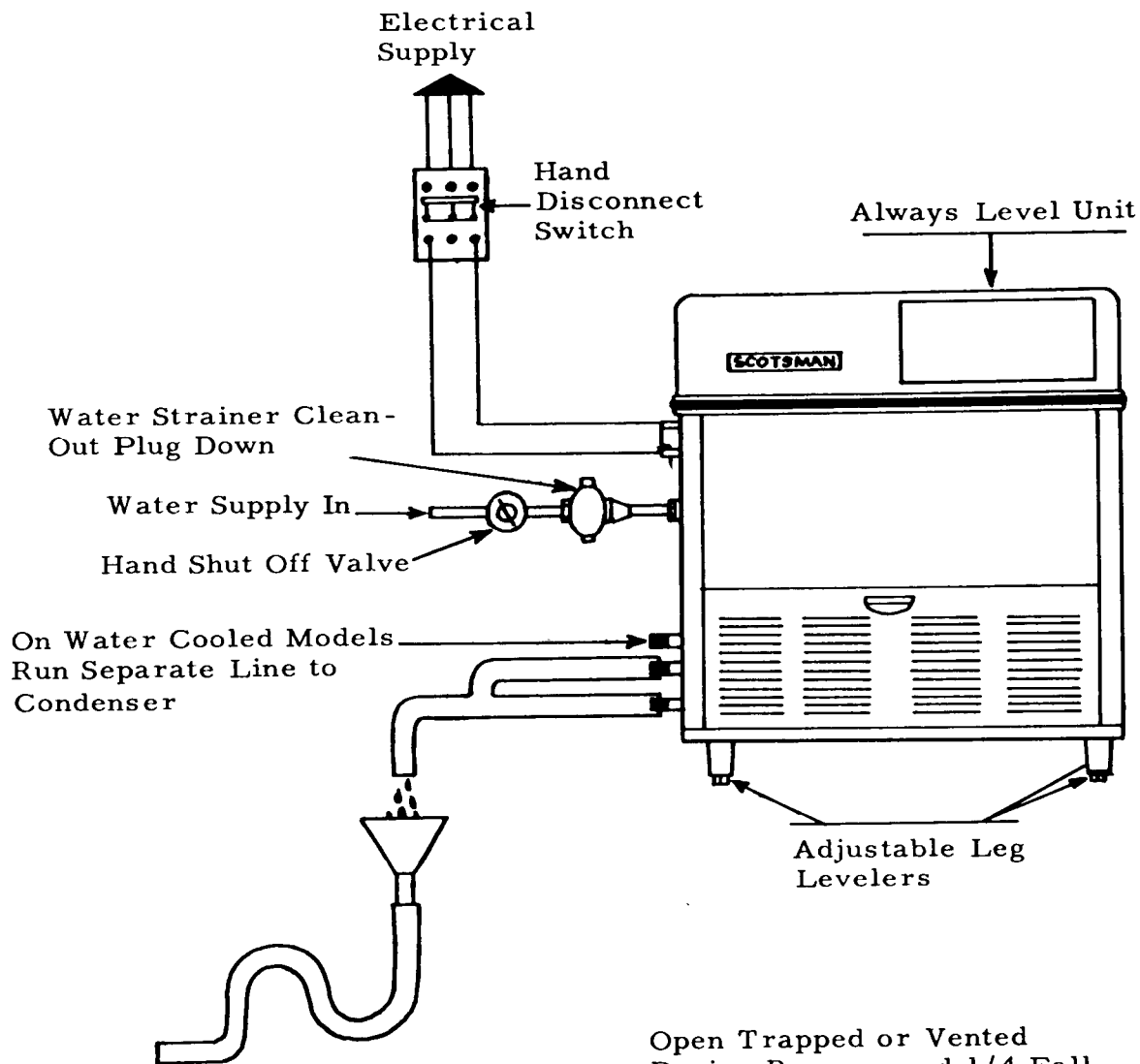

## INSTALLATION

### ELECTRICAL CONNECTIONS:

#### SF1WSJ

115 Volts, 60 Cycle, 1 Phase

20 Amp. Circuit

12 Gauge wire should be used for electrical hook-up. Conductors with third or ground wire are desirable.

Be certain that the Super Flaker is on its own circuit and individually fused. The maximum allowable voltage variation should not exceed 10 per cent of the nameplate rating even under starting conditions. Low voltage can cause erratic operation and may be responsible for serious damage to the overload switch and motor windings.

All external wiring should conform to the National Underwriters and local Electrical Code requirements. Usually an electrical permit and the services of a licensed electrician will be required.

### ELECTRICAL INSTALLATION:

#### SF1WSJ

Compressor	1/2 HP	Copelaweld: RSF2-0050-1AA-207 2 pole, 3500 RPM
	Voltage	115
	Amp. rating F.L.A.	10.0
	Cycle	60
	Phase	Single
Gear Drive Motor	1/10 HP	Queen Products
	Voltage	115
	Amp. rating	4.0
	Cycle	60
	Phase	Single Thermally Protected

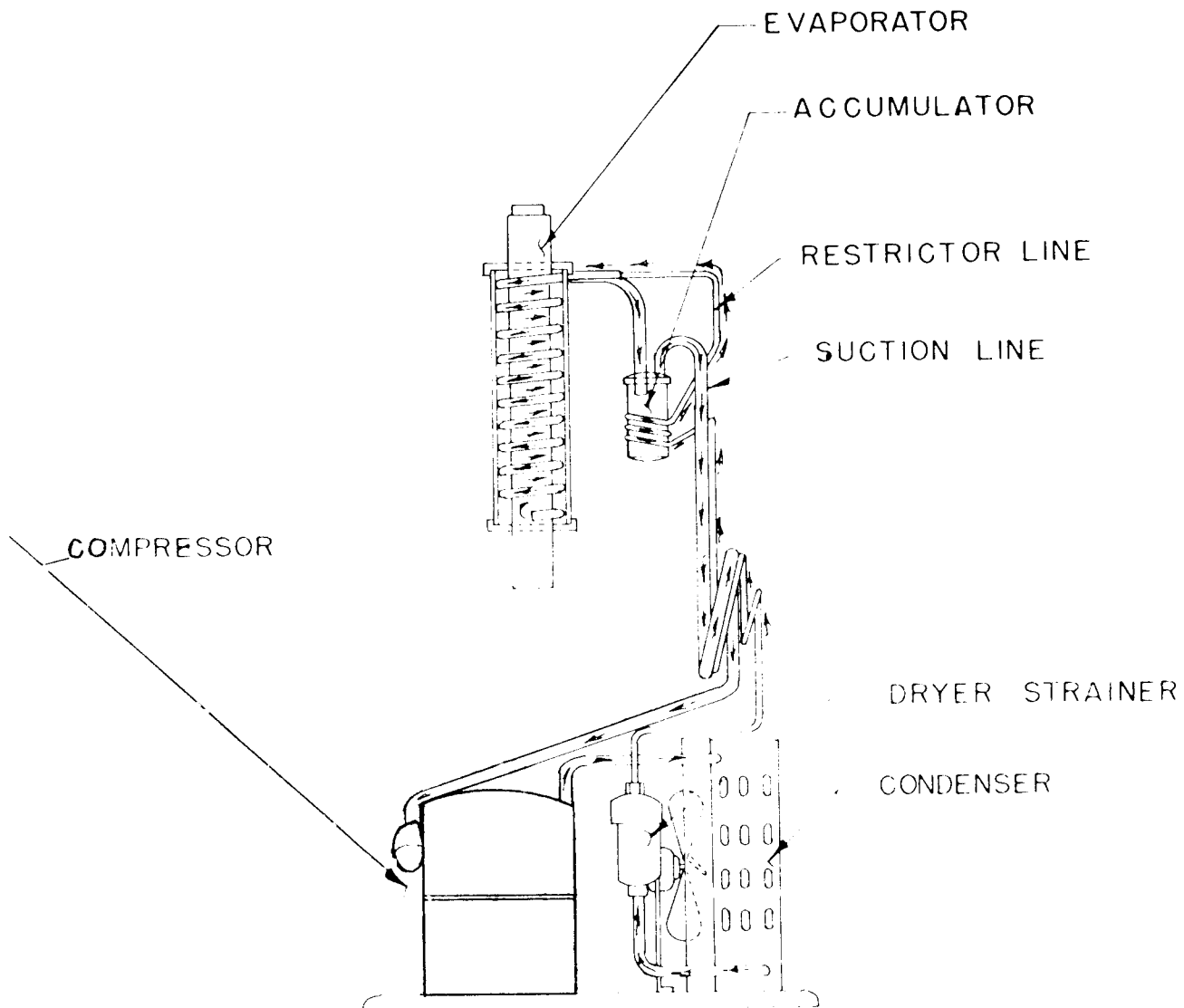

REFRIGERATION CYCLE SF-1 ALL MODELS

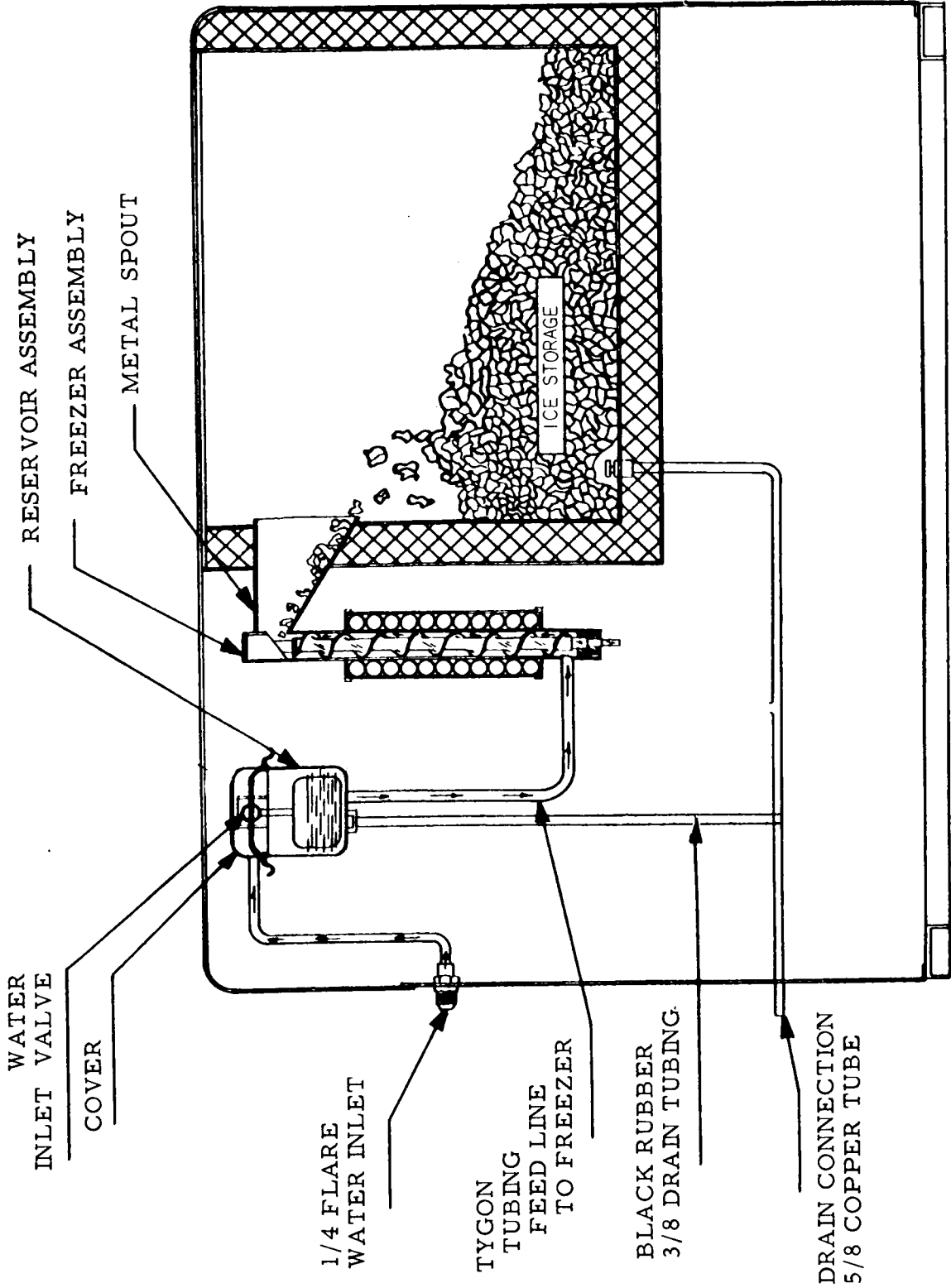

WATER SCHEMATIC

SF-1WSJ

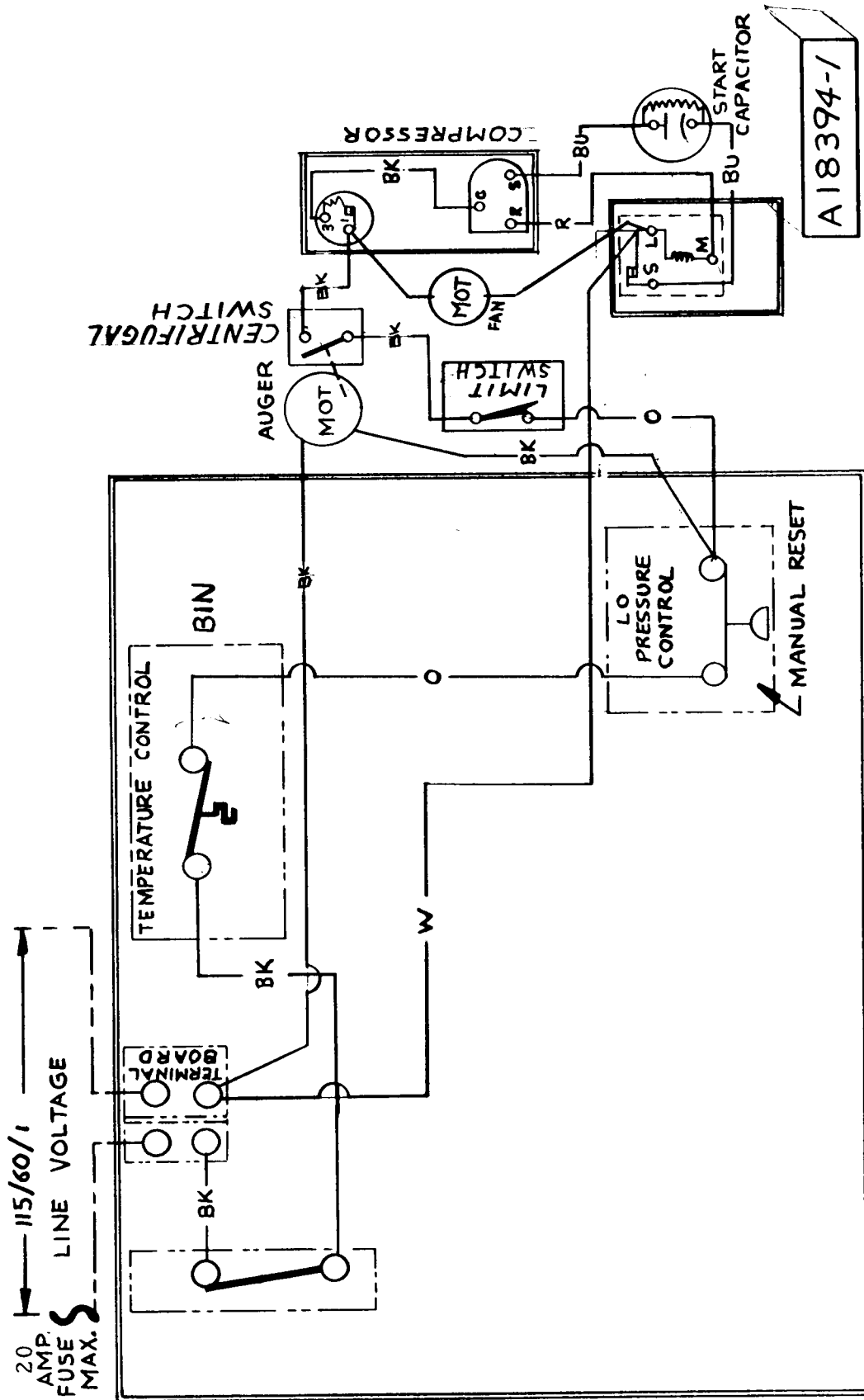

WIRING DIAGRAM

Air Cooled SF1J

115/60/1



WIRING DIAGRAM

Water Cooled SFIWJ

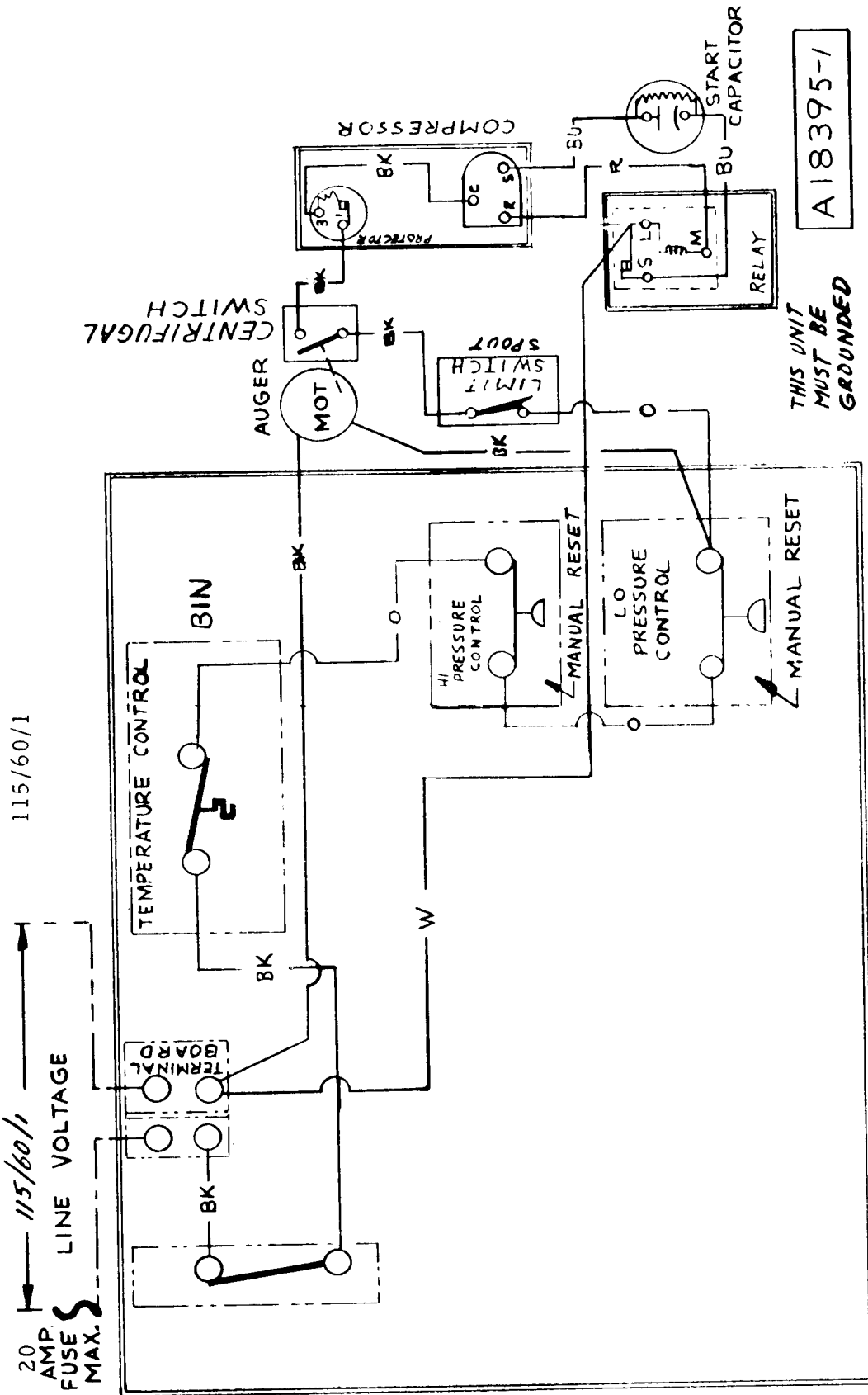

### FINAL CHECK LIST

1. Is the unit level? (IMPORTANT)
2. Have all electrical and piping connections been made?
3. Has the voltage been tested and checked against the nameplate rating?
4. Is the water supply valve open and the electric power on?
5. Is the water reservoir filled and shut off? All packing removed?
6. Have unit and bin been wiped clean?
7. Has owner been given the Operating Instruction Sheet, and has he been instructed on how to operate the machine?
8. Have the installation and warranty cards been filled out and mailed to the factory?
9. Check all refrigerant and conduit lines to guard against vibration and possible failure.
10. Installed in a well ventilated room where ambient temperatures do not fall below 50<sup>o</sup> Fahrenheit.
11. Is unit installed with a minimum 4" air space around sides and back?

## SERVICE

**STARTING THE MACHINE:** When the machine is placed and inspected as per instructions and all plumbing and electrical connections are completed and tested, turn on the water supply. Be sure the float cover is removed to check on the float operation and water level in the water reservoir. Be sure the water reservoir is filled before starting the machine. Water level should be 1/4 inch below the reservoir overflow.

When this is completed, turn on the manual switch on the front of the cabinet and the machine is in automatic operation. In two to three minutes ice will start dropping off the worm shaft and out the ice chute. Let the machine operate for at least 30 minutes and check for any excess noise other than the normal compressor noise. Test the ice storage control bulb by holding a handful of ice around the bulb until the machine shuts off. One minute should be normal for the control to function. Within minutes after the ice is removed, the bulb will warm up and the machine will automatically start up. The control is factory set and should not be reset until this test is made. Normal setting of this control should be approximately 35 degrees cut-out and 45 degrees cut-in.

Check pressure settings at the time of start-up. On the water-cooled models set the head pressure at 135 PSI. On the air-cooled models the head pressure will vary between 130 and 145 PSI head pressure. The frost line should extend out of the accumulator if properly charged with refrigerant and suction pressure will range between 14 and 16 PSI with 50° F inlet water.

Check the hand reset low pressure control setting. This safety device should be set at approximately 5 PSI below normal operating suction pressure and should cut off in case of interruption in water supply, shortage of refrigerant, low ambient or any other cause of abnormally low suction pressure.

Explain the machine to the owner, showing him how the machine works and go over the owner's instruction sheet with him. Answer all the owner's questions about the machine, and do not leave with any doubt in the owner's mind about the machine, how to operate it or where to reach you should he need service on the machine. Call back the next day to check the machine again and answer any other questions the owner may have.

Service gauge connections are available on both high and low side service valves on water cooled models, suction valve only on air cooled models.

To install gauges to any of these connections, use lines with tire type service valve adapter. Purge free of any non-condensable gases before starting any test operation.

**REFRIGERANT CHARGE:** The below refrigerant charge is approximate. When charging, set at 135 PSI head pressure and charge so that the frost line extends out of the evaporator and into the accumulator after fifteen minutes of operation.

Model	Freon Charge
Air-Cooled	26 oz. R-12
Water-Cooled	24 oz. R-12

## SERVICE

**WATER SYSTEM:** A water level is maintained in the water reservoir by a float operated valve. Water is piped from the water reservoir to the freezing chamber by a gravity feed line maintaining an equal water level.

The water reservoir is equipped with a 2 inch air gap to prevent back siphoning and meet all health codes.

The water level in the water reservoir is adjusted by bending float arm. The water level should be set 1/4 inch below the moulded in overflow well.

A water strainer must be installed in the supply line. Use strainer sent with machine.

**ELECTRICAL SYSTEM:** The super Flaker Model SF-1J is designed to work on standard electrical supply 115 volts, 60 cycle single phase.

Supply voltage should not vary more than plus or minus 10 percent over nameplate rating.

Special voltage requirements are available on special order. Therefore, always check nameplate for this information before connecting electrical supply.

The electrical circuit consists of condensing unit, freezer gear motor, storage bin thermostat ON and Off switch and spout micro (safety) switch.

A. **CONDENSING UNIT:** The starting capacitor and starting relay are housed and fastened to the motor compressor.

B. **GEAR MOTOR TO FREEZER:** Models SF1J are equipped with a 1/10 horsepower direct drive gearmotor. A speed sensing switch mounted on top of the motor of the gear unit will open and stop the compressor when the RPM of the gearmotor is less than 900. At 1200 RPM it will close, starting the compressor.

In an actual operation any condition that may cause excessively hard ice and overloads within the freezer assembly; water interruptions, cold ambients, etc. is transmitted to the gearmotor reducing it's speed. When gearmotor slows down to approximately 900 RPM the speed sensing switch opens the electrical circuit to the compressor. The compressor stops and no more ice is produced, meanwhile the gearmotor continues to run, clearing the overload condition and gradually resumes full speed. At 1200 RPM gearmotor speed sensing switch closes compressor circuit causing the normal icemaking process to begin once more.

Any freeze up possibility is thereby automatically cleared out by the gearmotor.

C. STORAGE BIN THERMOSTAT: Thermostat control body is located in electrical control box. The thermostat sensing tube is threaded into the ice storage bin where it automatically stops the icemaker when ice bin fills to sensing tube level and restarts icemaker when ice is removed. Factory settings are 35° cut out, 45° cut in.

Altitude correction begins at 2,000 feet, cut in and cut out screws should be adjusted equally, not more than 1/4 turn at a time.

D. MICRO SAFETY SWITCH: The micro switch is located in the top of the ice chute. The switch is operated by a pressure plate inside the ice chute. Ice backs up in the chute if the storage bin thermostat fails. Micro switch will shut off the condensing unit only, when operated.

E. ON-OFF SWITCH: A manual on-off switch is located in control box.

F. SAFETY CONTROL: High head pressure. On water cooled models only. Factory set to stop entire icemaker if head pressure reaches 190# PSIG. Manual reset, adjustable.

G. SAFETY CONTROL:- Low back pressure. Used on both models, this control is set to electrically "open" at 2# PSIG, stopping entire icemaker. manual reset, non adjustable.

## REMOVAL & INSTALLATION OF PARTS

### CABINET TOP (HOOD)

1. Remove two back end screws of chrome strip.
2. Pull out tape concealing screws.
3. Remove balance of screws in chrome strip.
4. Lift off hood.

### HOOD SERVICE DOOR TOP

1. Remove screws from edges.
2. Lift out door.

### CABINET SIDE SERVICE DOOR

1. Remove four screws on edges.
2. Lift out door.

### CABINET FRONT SERVICE DOOR

1. Front door pulls out.

### CABINET REAR SERVICE DOOR

1. Remove four screws on corners of rear service door.
2. Pull door out.

### ICE STORAGE DOOR

1. Lift door up, slide back 6". Remove thumb screw that attaches safety lanyard to back of door.
2. Door will now slide out. Lift front edge slightly to clear hood lip.

### ICE STORAGE DOOR FRAME

1. Remove six screws at bottom and sides.
2. Remove screw in frame back.
3. Frame will now lift out.

### MOTOR COMPRESSOR

1. Remove gas charge .
2. Disconnect wiring from the compressor.
3. Loosen suction and discharge lines and cap off.
4. Remove the compressor hold-down nuts and lift compressor out of the unit.
5. Reverse steps 1 through 4 in replacing compressor.

## SERVICE

### FREEZER ASSEMBLY

1. In most instances, it will be faster to remove freezer by first removing cabinet top or hood. (See Removing and Installing Cabinet Parts.) Assembly can be changed if necessary through hood top panel.
2. Shut off water supply to unit, remove top and left side service panels.
3. Disconnect water inlet line at reservoir. Remove water supply tube at freezer and drain freezer.
4. Purge off refrigerant, unsweat suction line, disconnect capillary line at drier. Cap off all lines so no moisture can enter system.
5. Remove insulation pieces around spout, also the spout proper.
6. Remove 3 bolts holding fiber adapter base to gearmotor top cover, lift freezer out of cabinet.
7. Remove fiber adaptor spout front and back plates from old freezer and install on new replacement.
8. Re-install in reverse of above.

### FREEZER WORM SHAFT

1. Turn unit off, before removing worm shaft.
2. Shut off water supply to unit.
3. Remove hood service doors.
4. Remove top and bottom straps around spout insulation pieces, remove pieces.
5. Remove two slotted head screws which fit through top chamber wall into ice breaker.
6. Tap spline coupling loose on bottom end of freezer worm shaft.
7. Complete worm shaft with ice breaker attached will now come out by lifting up on freezer cap pull ring. NOTE: Top half of water seal will come with worm shaft.
8. To remove ice breaker from shaft, first remove retainer ring in top of ice breaker.
9. Remove freezer cap and pull ring from ice breaker.
10. Remove cap screw holding shaft through bearing and pull worm shaft free from ice breaker and bearing.
11. If shaft is defective, remove water seal top half and put on new worm shaft before reassembling--when reassembling, by reversing above, put a small amount of Vaseline on shaft end. This will allow shaft to slide smoothly through rubber bottom half of water seal without tearing it.

### WATER SEAL

1. To replace water seal, follow steps 1 through 7 under Worm Shaft Removal.
2. Remove 3 bolts holding freezer to fiber mounting adapter.
3. Lift freezer off adapter just high enough to allow bottom bearing and bottom half of water seal to be removed from bottom of freezer tube.
4. Lightly grease bottom half of new water seal and insert face up approximately 1/2" in bottom of freezer tube.
5. Insert bottom bearing in bottom of freezer tube, force approximately 1/8" past bottom tube end. This will allow the positioning ring on fiber adaptor to properly position freezer tube when tightening up the three mounting bolts.
6. After securing mounting bolts, put new top half of water seal on worm shaft the same way as the old seal was removed.
7. Carefully insert worm shaft assembly in freezer tube and into spline coupling on bottom.
8. Replace ice breaker screws, insulation pieces and unit is ready to resume operation.

## SERVICE

### STORAGE BIN THERMOSTAT:

1. Disconnect electrical supply.
2. Remove bin thermostat bulb from bin location along with its capillary tube.
3. Remove control box cover.
4. Disconnect two spade type electrical leads.
5. Loosen two screws in control mounting bracket.
6. Replace with new control and reassemble in reverse of above.
7. CAUTION: Always check new control power element charge before installation to assure receiving an operative control. A handful of ice on bulb will register an audible 'click' at cut off.

### WATER RESERVOIR

1. Remove service panel in cabinet hood.
2. Turn off water supply and drain reservoir.
3. Remove 1/4 inch nylon inlet water line..
4. Remove 1/2 inch plastic feed line to freezer.
5. Remove two screws holding reservoir bracket to wall.
6. Lift out reservoir.
7. To replace, reverse procedure.



## SERVICE

### MICRO SWITCH IN SPOUT

1. Remove hood service panel.
2. Remove insulation pieces around freezer spout.
3. Remove micro box cover, loosen two screws at rear of box holding switch in place, lift up.
4. Disconnect electric leads.
5. Reassemble with new micro switch.

### MANUAL ON AND OFF SWITCH

1. Remove front service door.
2. Remove two screws holding switch to bracket.
3. Disconnect electrical leads from switch.
4. Remove switch.
5. To replace, reverse procedure.

### FREEZER GEARMOTOR

1. The easiest way to change the gearmotor is to remove complete cabinet hood as explained earlier in this section. If necessary because of location you can change by removing top service panel.
2. Pull off left side service panel and look up on underside of left side cabinet panel: 4 screws secure this gearmotor to frame.
3. Remove the four wire leads (2 on micro switch on top of motor, 2 from motor into control box.)
4. Remove 3 bolts thru fiber adapter into gearmotor cover and the 4 bolts holding gearmotor to mounting base.
5. Lift freezer adapter assembly off gearmotor and pull gearmotor out thru left side.

CHASSIS FRONT VIEW  
SF1WWSJ - Water Cooled

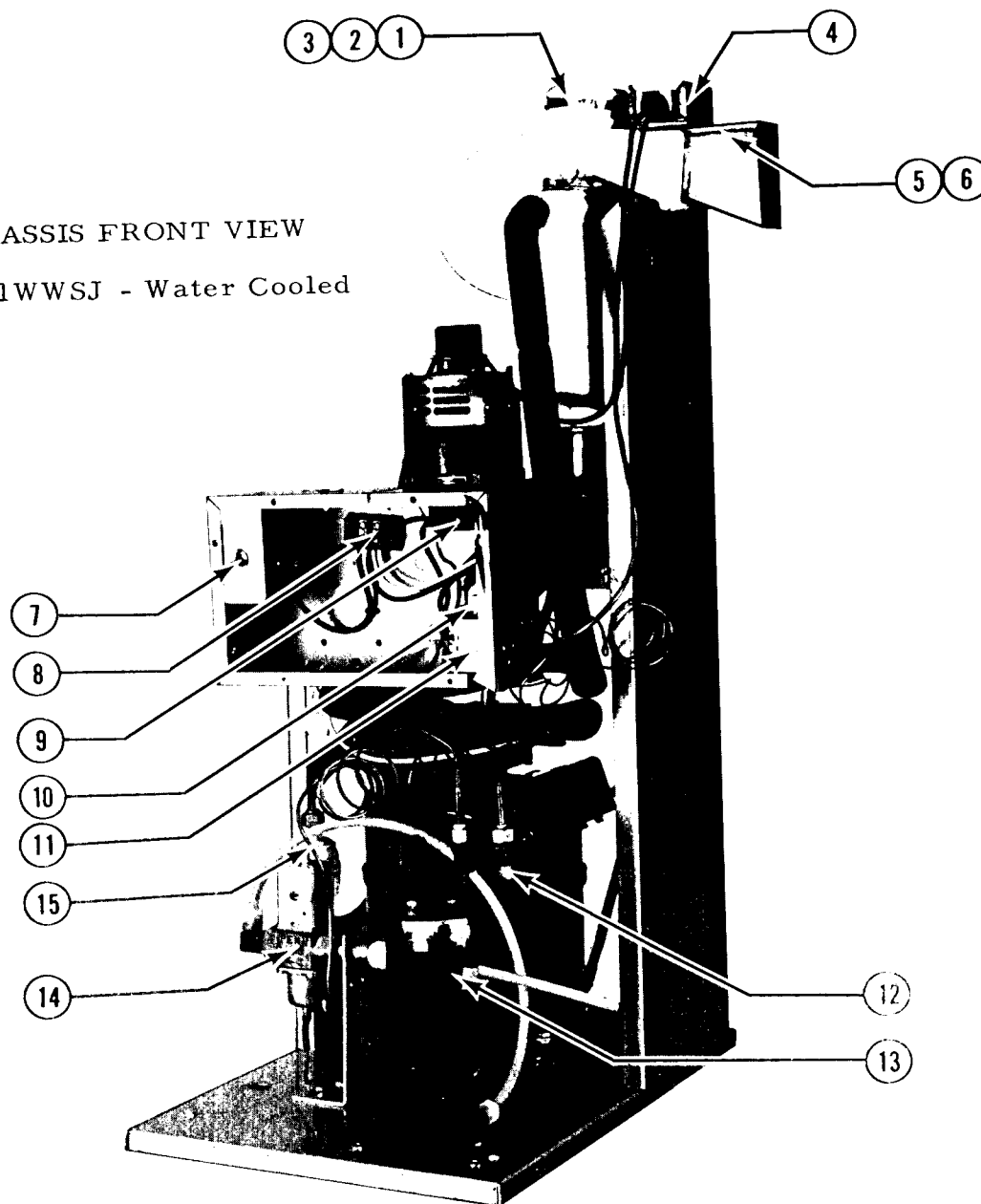

ITEM NO.	PART NO.	DESCRIPTION
1.	A-15070	Insulation - left
2.	A-15071	Insulation - right
3.	A-8736	Insulation - straps
4.	12-1018	Spout Micro Switch
5.	A-16360	Spout Pressure Plate
6.	2-1321	Pressure Plate Spring
7.	12-426-1	On - Off Switch
8.	12-813-4	Terminal Board
9.	11-354	Bin Thermostat
10.	11-357	Hi Pressure Control
11.	11-358	Low Pressure Control
12.		Hi Side Service Valve
13.	18-699-3	Water Cooled Condenser - (Packless)
14.	11-198	Water Regulating Valve
15.	2-350	Refrigerant Drier

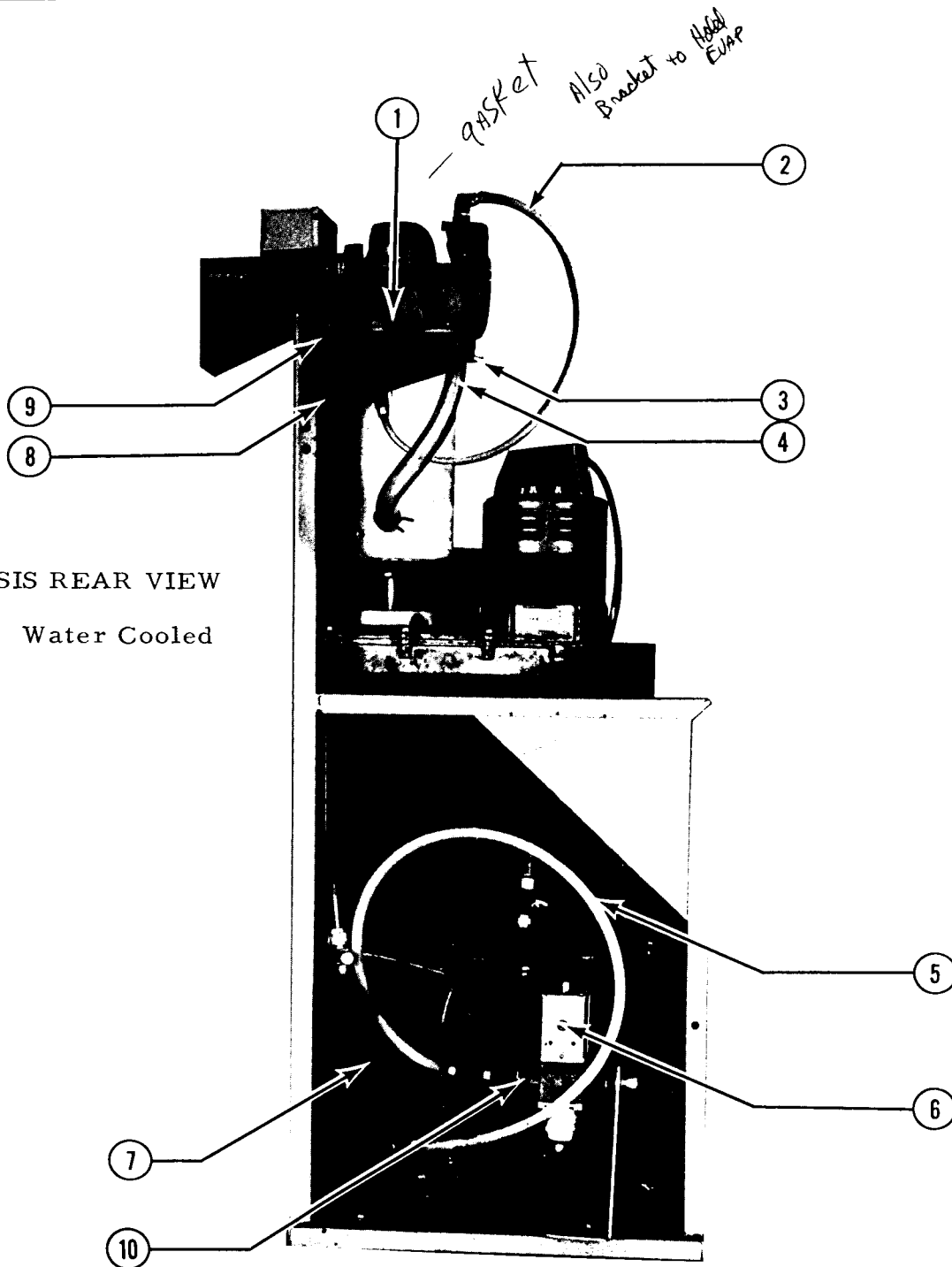

CHASSIS REAR VIEW  
SF1WWSJ Water Cooled

ITEM NO.	PART NO.	DESCRIPTION
1.	2-1793-1	Reservoir
2.	5-397-1	1/4" Nylon Tubing
3.	2-694	Hose Clamps
4.	13-674-9	Plastic Tubing
5.	5-397-2	3/8" Nylon Tubing
6.	11-198	Water Regulating Valve
7.	18-283	Water Cooled Condenser (Halstead - Mitchell)
8.	13-79-3	Drain Tube
9.	2-535	Hose Clamp
10.	16-588-3	Male Adapter

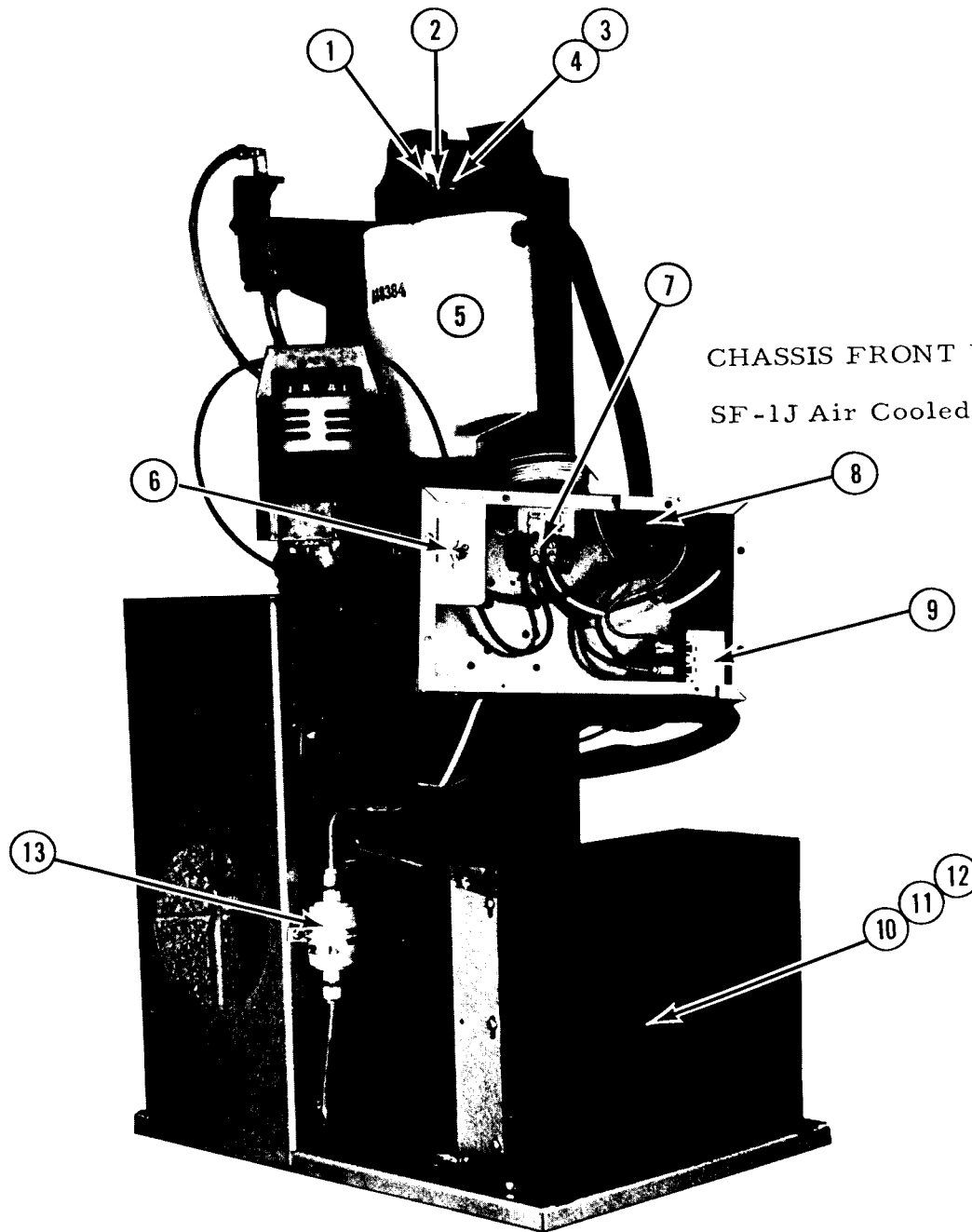

CHASSIS FRONT VIEW  
SF-1J Air Cooled

ITEM NO.	PART NO.	DESCRIPTION
1.	A-18430	Spout Plate
2.	3-1403-53	Mounting Screws
3.	A-14254	Spout Casting
4.	13-679	Spout Casting - O-Ring
5.	A-18384-2	Freezer Assembly
6.	12-426-1	On-Off Switch
7.	12-813-4	Terminal Board
8.	11-354	Bin Thermostat
9.	11-358	Lo Pressure Safety Control
10.	18-234	Air Cooled Condenser
11.	18-231	Fan Blade
12.	12-1575-1	Fan Motor
13.	2-350	Drier

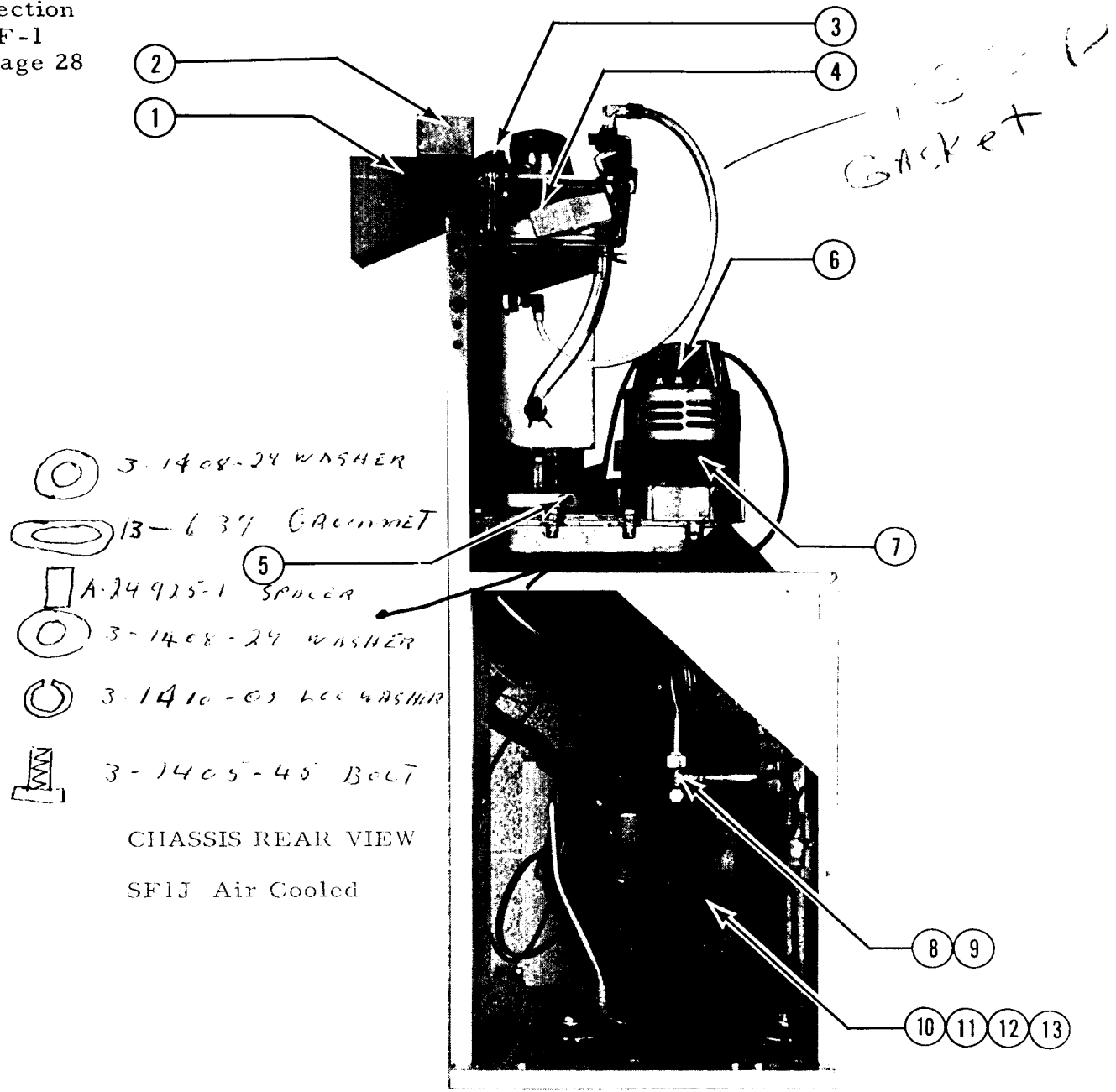

CHASSIS REAR VIEW

SF1J Air Cooled

ITEM NO.	PART NO.	DESCRIPTION
1.	A-21307	Spout Body only
2.	12-1018	Spout Micro Switch
3.	A-14256	Spout Knurled Nut
4.	2-1793-1	Plastic Reservoir
5.	A-18153	Drip Pan
6.	12-1644	Switch
7.	A-18380-1	Gear Motor Drive
8.	16-560	Suction Valve Core
9.	16-563	Suction Valve Cap
10.	<del>18-2210</del> 18-2200-21	Motor Compressor
11.	18-2200-26	Compressor Relay
12.	18-2200-29	Starting Capacitor
13.	18-2200-25	Compressor Overload

# FREEZER ASSEMBLY

## SF-1J MODELS

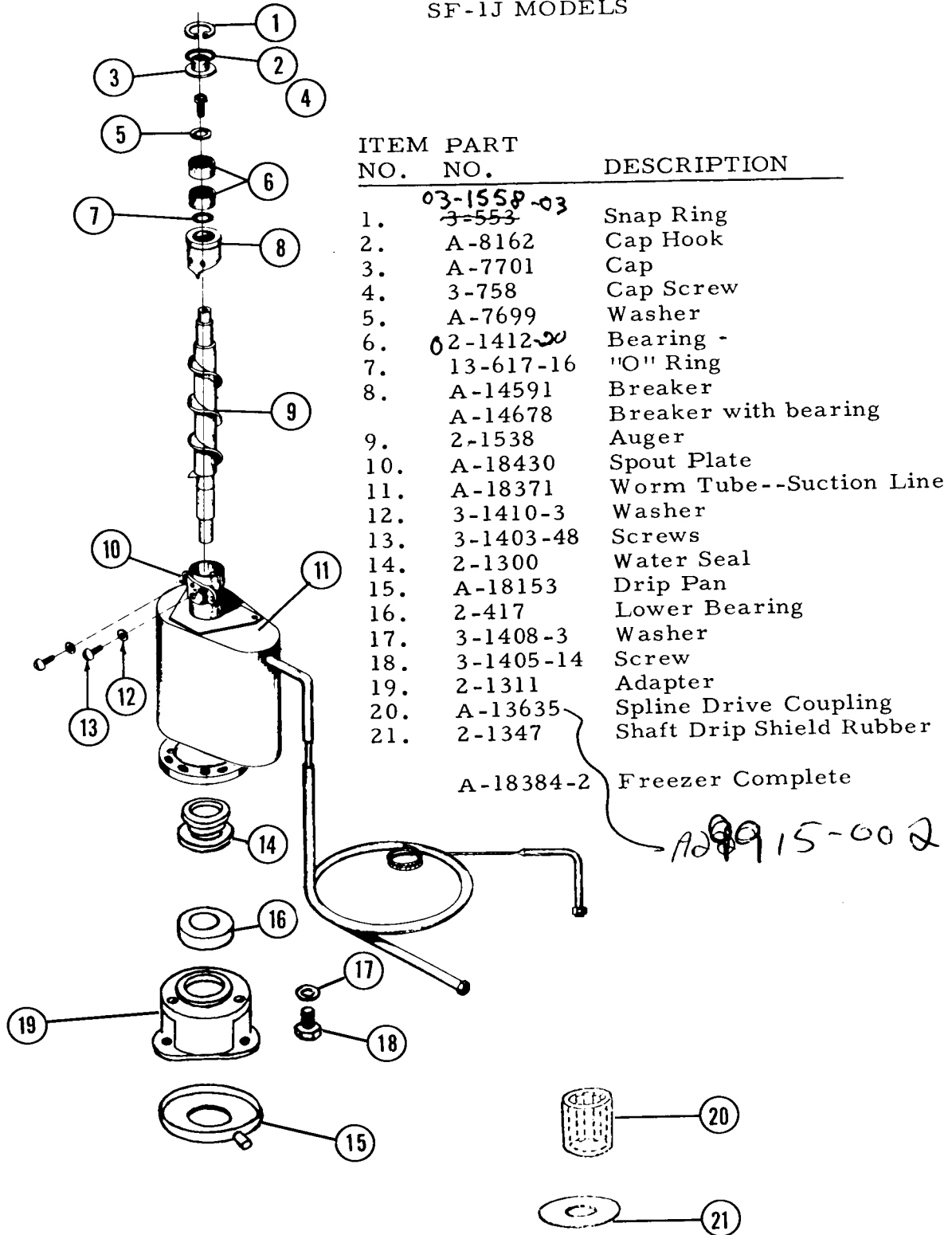

ITEM NO.	PART NO.	DESCRIPTION
1.	<del>3-553</del> 03-1558-03	Snap Ring
2.	A-8162	Cap Hook
3.	A-7701	Cap
4.	3-758	Cap Screw
5.	A-7699	Washer
6.	02-1412-00	Bearing -
7.	13-617-16	"O" Ring
8.	A-14591	Breaker
	A-14678	Breaker with bearing
9.	2-1538	Auger
10.	A-18430	Spout Plate
11.	A-18371	Worm Tube--Suction Line
12.	3-1410-3	Washer
13.	3-1403-48	Screws
14.	2-1300	Water Seal
15.	A-18153	Drip Pan
16.	2-417	Lower Bearing
17.	3-1408-3	Washer
18.	3-1405-14	Screw
19.	2-1311	Adapter
20.	A-13635	Spline Drive Coupling
21.	2-1347	Shaft Drip Shield Rubber

A-18384-2 Freezer Complete

*AD 8915-002*

RESERVOIR ASSY. 2-1793-1

1. 2-1793-2 Valve Assembly consisting of:  
Inlet Ell  
Straight Compression nut  
Compression Sleeve  
Valve Assembly with Float
2. 2-1793-3 Reservoir Cover
3. 2-1793-4 Reservoir Body
4. 2-1793-5 Reservoir mounting nut  
3/8-18

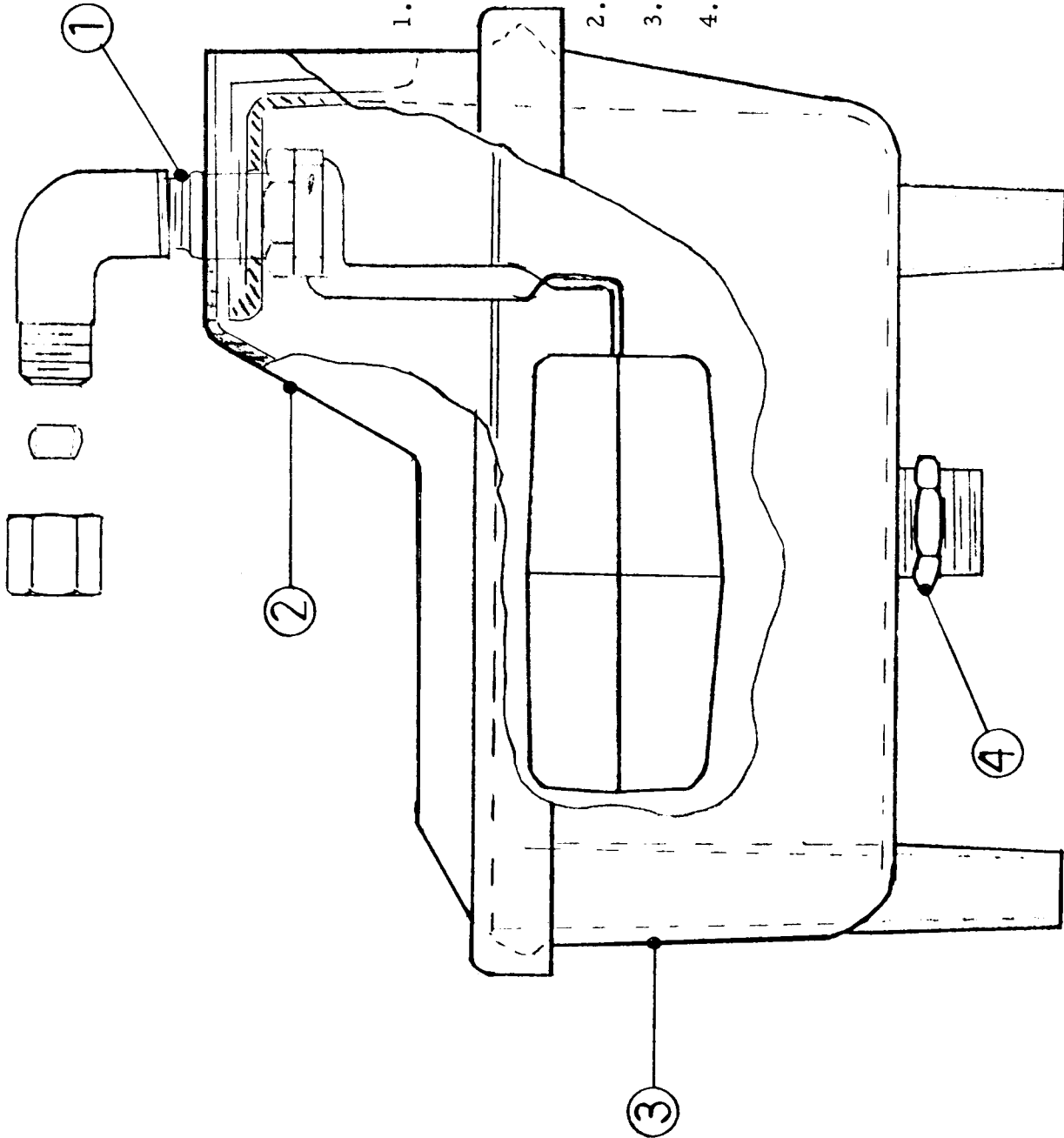

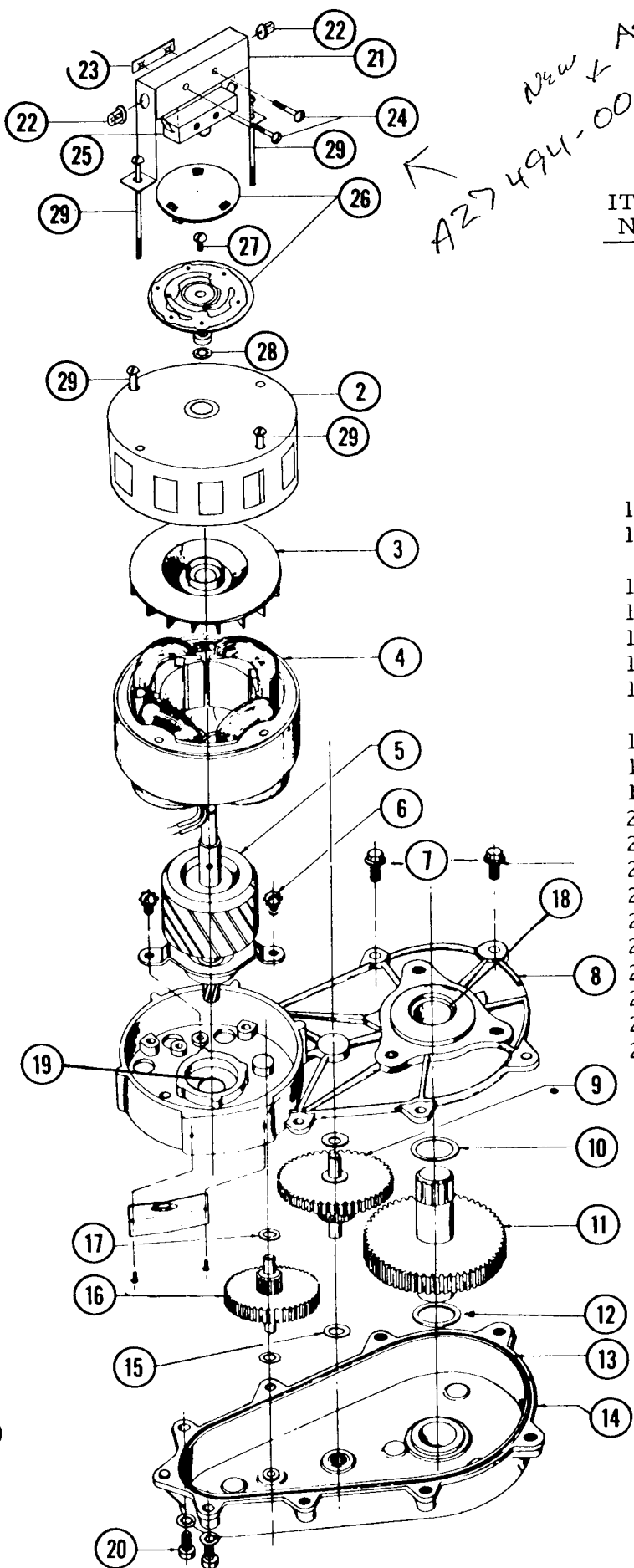

New Assy  
A27494-00

ITEM NO.	PART NO.	NAME
2.	A-17047	Motor Housing
3.	A-16915	Cooling Fan
4.	12-1400-1	Stator Assy.
5.	A-19884-2	Rotor Assy.
6.	3-1245	Screws
7.	3-1251	Flange Screws
8.	A-16920	Gear Case Cover
9.	2-1521	Gear & Pinion
10.	3-1408-5	Washer
11.	2-1513	Gear & Output Shaft
12.	3-1408-4	Washer
13.	2-1505	"O" Ring
14.	A-16919	Gear Case Assy.
15.	3-1408-6	Washer
16.	2-1520	1st Gear & Pinion
17.	3-1408-7	Washer
18.	2-1503	Grease Seal
19.	2-1504	Grease Seal
20.	3-1252	Screw
21.	8-579	Switch Bracket
22.	12-1213-3	Snap Bushings
23.	3-886	Twin Speed Nut
24.	3-1403-9	Screws
25.	12-1644	Switch
26.	A19898	Synchro Snap Assy.
27.	3-1403-10	Screw
28.	3-1417-6	Washer
29.	3-1403-43	Motor Bolts

A-18380<sup>001</sup> Gear Motor Assy. Complete

Output Shaft turns at 10 RPM





SF-1J CASE ASSEMBLY

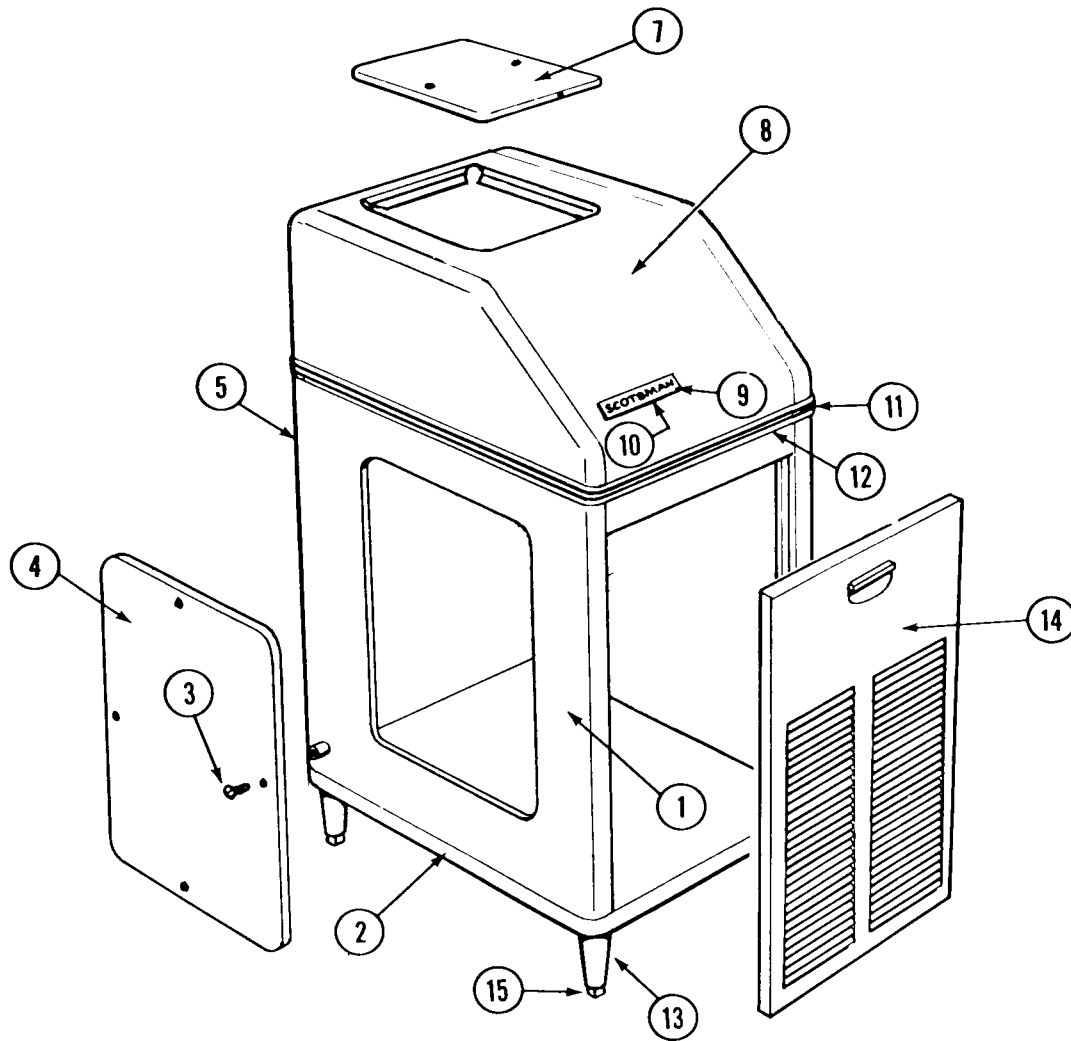

<u>ITEM NO.</u>	<u>PART NO.</u>	<u>NAME</u>
1.	A-20585	Case Assembly (less doors)
2.	A-8902-1	Moulding Strip (bottom) (2 reqd.)
3.	3-775	Screw (s,s)
4.	S-6713	Side Door
5.	A-8740	Rear Door (*)
7.	A-7676	Top Door
8.	A-20925	Case Hood (less doors)
9.	15-156	Scotsman Emblem
10.	3-271	Speed Nuts
11.	15-324	Plastic Trim Insert
12.	S-6218	Moulding Strip (top)
13.	A-15803	Legs (4 reqd.)
14.	A-15791	Front Door
15.	8-522	Leg Levelers

(\*) Not Shown

SERVICE ANALYSIS

SYMPTOM	POSSIBLE CAUSE	CORRECTION
Unit will not run	<p>Blown Fuse</p> <p>Thermostat set too high</p> <p>Loose electrical connection</p> <p>Switch in OFF position</p> <p>Inoperative master switch</p>	<p>Replace fuse and check for cause of blown fuse.</p> <p>Adjust thermostat. 35° cut-out and 45° cut-in.</p> <p>Check wiring.</p> <p>Turn switch to ON.</p> <p>Replace switch.</p>
Compressor cycles intermittently	<p>Low voltage</p> <p>Dirty Condenser</p> <p>Air circulation blocked</p> <p>Inoperative condenser motor</p> <p>Non-condensable gases in system</p>	<p>Check for overloading.</p> <p>Clean.</p> <p>Move unit to correct.</p> <p>Replace.</p> <p>Purge off.</p>
Making wet ice	<p>Surrounding air temperature</p> <p>Under or over-charge of refrigerant</p> <p>High water level in water reservoir</p> <p>Faulty compressor</p>	<p>Correct or move unit to cooler location</p> <p>Recharge with the proper amount.</p> <p>Lower to 1/4 inch below overflow pipe.</p> <p>Repair or replace.</p>
Low ice production	<p>Loss of refrigerant, under or over-charge of refrigerant.</p> <p>Dirty or plugged condenser</p> <p>Low water level in water reservoir</p> <p>Partial restriction in capillary tube or drier</p> <p>Inlet water strainer partially plugged.</p> <p>Corroded or stained worm shaft due to water condition</p>	<p>Check and recharge with proper amount of refrigerant.</p> <p>Clean condenser</p> <p>Adjust to 1/4 inch below overflow pipe.</p> <p>Moisture in system. Over-charge of oil in system. Remove charge and drier. Replace and recharge system.</p> <p>Remove screen and clean.</p> <p>Remove worm shaft and clean.</p>
Machine runs but makes no ice	<p>Loss or under-charge of refrigerant</p> <p>Drive gearmotor or drive coupling stripped.</p> <p>Water not entering freezing chamber</p> <p>Moisture in system</p> <p>Water seal leaking</p> <p>Water supply to unit off</p>	<p>Check for leaks and recharge</p> <p>Check. Repair and/or replace</p> <p>Plugged strainer or supply line. Check and clean. Air lock in gravity feed line. Check and remove air lock.</p> <p>Check and remove charge and drier. Replace and recharge.</p> <p>Replace seal.</p> <p>Restore water supply to icemaker</p>

SERVICE ANALYSIS

SYMPTOM	POSSIBLE CAUSE	CORRECTION
Water Leaks	<p>Defective water seal Gravity feed line leaking 'O' ring in spout casting leaking</p> <p>Storage bin drain &amp; connecting fittings leaking. Water level in reservoir too high</p>	<p>Replace Check hose clamps Remove spout casting and install new 'O' ring Check and repair.</p> <p>Adjust to 1/4 inch below overflow pipe.</p>
Excessive noise or chattering	<p>Mineral or scale deposit on auger and inner freezing chamber walls.</p> <p>Low suction</p> <p>Intermittent water supply</p> <p>Water level in reservoir too low</p> <p>Gear motor loose on frame</p> <p>Gearmotor end-play or worn bearings.</p>	<p>Remove and manually polish auger, polish inner chamber walls of freezer barrel.</p> <p>For lighter concentrations use Scotsman Ice Machine Cleaner periodically. Add gas to raise suction pressure. Check &amp; clean water strainer. Check gravity feed line for air lock. Remove air lock. Adjust to 1/4 inch below overflow pipe.</p> <p>Tighten.</p> <p>Repair or replace.</p>
Machine continues to run with full storage bin	Storage bin thermostat not properly set	Reset or replace. 35° cut-out, 45° cut-in Check operation with handful of ice.
Gearmotor noise	Low on oil	Remove case cover to check for proper oil level. Top of gears should be covered. Use Sun Oil Co. Prestige 50 AEP.

## MAINTENANCE INSTRUCTIONS - FLAKERS

THE FOLLOWING MAINTENANCE SHOULD BE SCHEDULED THREE TIMES PER YEAR ON ALL SCOTSMAN SUPER FLAERS. CALL YOUR AUTHORIZED SCOTSMAN SERVICE DEPARTMENT.

1. Check and clean water strainers and float valve. Depress float valve to insure full stream of water.
2. Check water level and machine level, keep water level below overflow, but as high as possible and still not run out of spout opening with machine off. Water droplets come out of spout with ice at all times. Adjust as required.
3. Clean reservoir and interior of freezer using SCOTSMAN Ice Machine Cleaner.
  - A. If machine has been cleaned regularly and no problems such as dry ice or chatter are noticed, clean as per the following instructions:
    - a. Set main switch to OFF.
    - b. Remove all ice from storage bin.
    - c. Turn off water supply or block float. Drain reservoir by disconnecting tube between reservoir and freezer. After draining, reconnect tubing.
    - d. Set main switch to ON and pour cleaning solution into reservoir. Do not fill above overflow tube.  
Models SF1 & SF75--Use 4 oz. of Scotsman cleaner and 1 qt. hot water.
    - e. Continue to make ice on solution until the solution is used up and reservoir is empty.
    - f. Set main switch to Off. Remove overflow tube, wash and rinse reservoir, replace overflow tube, turn water on or remove float block.
    - g. Turn MAIN SWITCH to ON. Let unit run for at least (15) minutes to flush out any cleaning fluid. Check ice for acid taste.-- run until ice tastes sweet.
    - h. Turn MAIN SWITCH to OFF. Add hot water to ice bin, using this melt water, thoroughly wash and rinse all surfaces within the storage bin.
    - i. Turn MAIN SWITCH to On. Replace Service Door. Unit is ready for normal operation.

### MAINTENANCE INSTRUCTIONS (Continued)

NOTE: Cleaning requirements vary according to local water conditions. Visual inspection of the auger before and after cleaning will indicate best procedure to be followed in local areas.

4. Check high and low side pressures. On air-cooled models head pressures range between 130 and 145 PSI. Suction pressure should be above 12 PSI and will range up to 16 PSI depending upon water and ambient temperatures.
5. Check gearmotor operation. Normal running temperatures are in the area of 160° fahrenheit, which is hot to the touch. Check operation of centrifugal switch and the micro switch it actuates. When micro switch is actuated, compressor stops, gearmotor continues to run.
6. Check top bearing of freezing tube. Remove retainer ring around edge of stamped brass cap. If moisture is around bearing, wipe up and remove grease. Add new grease. Use Beacon No. 325. Replace cap and retainer ring.
7. Clean air-cooled condenser. Inform customer to clean frequently. Always shut off machine when cleaning.
8. Oil condenser fan motor when possible.
9. Check for refrigerant leaks and proper frost line. Should frost out of accumulator at least one-half way to compressor, and in some areas back to service valve.
10. Check for water leaks. Tighten drain line connections. Run water down bin drain line to make sure it is open.
11. Check quality of ice. Ice should be wet when formed, but will cure rapidly to normal hardness in bin.
12. Check thermostat and pressure plate cut off in spout. Micro switch cuts off only compressor. Bin thermostat should be set at 10° differential and should keep entire machine off at least twenty minutes in high ambients (longer in low) during normal operation. Settings are 35° cut out, 45° cut in.

PARTS LIST  
SF1WSJ

ELECTRICAL COMPONENTS

Bin Thermostat	11-354
Micro Switch-Spout	12-1018
On/Off Switch	12-426
Terminal Board	12-813-4

CONDENSING UNIT (Copelaweld 115/60/1 1/2 HP)

Motor-Compressor	18-2210
Dryer	2-350
Relay	18-2200-26
Starting Capacitor	18-2200-29
Overload	18-2200-25
Fan Motor	12-1575-1
Fan Motor Wire Lead	12-1573-2
Fan Blade	18-231
Fan Shroud	A-12109
Tire Type Service Valve Cap	16-563
Tire Type Service Valve - core only	16-560

MISCELLANEOUS

Spring Clamp Pliers	50-46
Worm Tube Nut Wrench	A-8497
Ice Scoop	2-540
Ice Machine Cleaner - 8 oz. bottle	19-343
Grey Spray-On Touch-Up Paint	10-153
Tygon Tubing - 9/16" ID	5-179
Tygon Tubing - 1/2" ID	5-186
Rubber Tubing - 3/8" ID	13-79
Clamp (for 5-179)	2-536
Clamp (for 5-186)	2-536
Clamp (for 5/8 drain tube)	2-534
Clamp (for 11/16 drain tube - Green)	2-535
Retainer Ring Plier	50-637

PARTS LIST  
SF1-J

DRIVE CIRCUIT

Gearmotor assembly	A-18380-1
Spline Coupling	A-13635
Fiber Adaptor Bracket	2-1311
Rubber Drip Shield - Fits Gearmotor Shaft	2-1347
Sliding Door - Ice Storage (Stainless Steel)	A-15559
Sliding Door - Ice Storage(Plastic)	2-1735
Door Stop Lanyard	2-1736
Wing Screw to Door	3-1276
Pan Screw to Frame	3-1403

FREEZER ASSEMBLY COMPLETE

Freezer Assembly Complete	A-18384-2
Ice Breaker	A-14591
"O" Ring	13-617-16
Top Bearing	2-1412
Cap Screw	3-758
Worm Tube Washer	A-7699
Worm Tube Cap	A-7701
Retainer Ring	3-553
Worm Shaft	2-1538
Water Seal	2-1300
Bearing, Bottom	2-417



PARTS LIST  
SF1-J

CABINET PARTS	SF1J	SF1WSJ
Machine Case (less doors)	A-20585	A-18291
Storage Bin Assembly	None	A-19046
Drain Assembly, Female	None	2-1742
Drain "O" Ring	None	13-617-11
Thermo Bulb Studs (2)	None	2-1615
Storage Drain Fitting (male)	None	2-1741
Case Hood Assembly (less doors)	A-20925	A-20924
Door Slide Assembly	None	A-16208
Bin Drain Screen	None	2-1741
Sliding Door - Stainless Steel	None	A-15599
Sliding Door - Plastic	None	2-1735
Door Glides (4)	None	3-640
Front Door	A-15791	A-15791
Rear Door	A-8740	A-8740
Left Side Door	S-6713	S-6713
Hood Top Door Assembly	A-7676	A-7676
Rear Moulding Strip	S-6218	S-3646
Front Moulding Strip	A-8902-1	A-5796
Emblem	15-156	15-156
Leg	A-15803	A-15803
Leg Leveler	8-522	8-522
Plywood Crate	1-648	1-649
WATER CIRCUIT		
Water Reservoir Assembly Complete		2-1793-1
Water Inlet Valve with Float		2-1793-2
Reservoir Cover		2-1793-3
Water Strainer		16-162
Reservoir Body only		2-1793-4